

## Instructions for Use

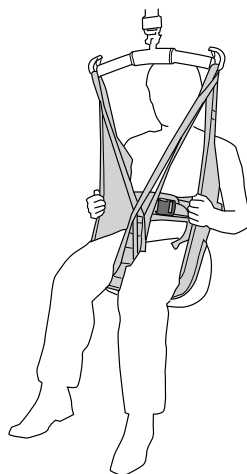

### Product Description

The Liko HygieneSling is designed in order to assist with dressing and undressing when lifting to and from the toilet, these are lifting situations that are often difficult for caregivers. Thanks to the large opening around the buttocks, dressing and undressing can be performed during the lifting procedure itself. The HygieneSling is easy to apply even if the patient is placed tightly in the wheelchair. The patient's arms should always be on the outside of the HygieneSling to ensure safety.

The HygieneSling usually works well for patients with long trousers and for patients wearing skirts and leggings.

It is necessary to have good body stability to sit well in the HygieneSling. It is often quite suitable for patients with a certain body stiffness. Mod. 41 is equipped with a belt. A correctly applied belt and the arms placed outside the sling, protects the patient from sliding out of the sling.

All sizes are manufactured in single-tone green polyester with reinforced, corduroy-lined leg support.

For people with compromised balance, or where the user needs one arm placed on the inside of the sling, it is recommended to use Liko HygieneSling with Safety belt Mod. 45. These models have a safety belt that holds and lifts the patient by the upper body if he/she sinks too low during the lifting procedure.

#### Alternative for patients with poor muscle tone

For lifts to/from the toilet for patients with poor muscle tone (and need more upper body support), it is recommended to use the Liko HygieneVest Mod. 55. Model 55 is equipped with built-in head support.

**⚠ The patient's arms must be kept outside HygieneSling Mod. 41 during the lifting procedure in order to avoid the risk of sliding out of the sling.**

#### Suitable lifts

The HygieneSling can be used along with all of Liko's overhead and mobile lifts. You can choose between the overhead lifts LikoGuard™, Likorall™, and Multirall™ or the mobile lifts Golvo™, Viking™, Uno™, and Liko™ M220/M230.

*In this document, the person being lifted is referred to as the patient, and the person helping them is referred to as the caregiver.*

#### **IMPORTANT!**



















Lifting and transferring a patient always involves a certain level of risk. Read the instructions for use for both the patient lift and lifting accessories before use. It is important to completely understand the contents of the instructions for use. The equipment should only be used by trained personnel. Ensure that the lifting accessories are suitable for the lift used. Exercise care and caution during use. As a caregiver, you are always responsible for the patient's safety. You must be aware of the patient's ability to make it through the lifting situation. If something is unclear, contact the manufacturer or supplier.

# Table of Contents

Symbol Description .....	3
Safety Instructions .....	4
Care and Maintenance .....	4
Definitions .....	4
How to Attach a Sling to Different Sling Bars .....	5
How to Attach a HygieneSling to a Sling Bar with 4 Hooks (Twin Bars) .....	7
Lifting from Wheelchair to Toilet .....	7
Returning from Toilet to Wheelchair .....	8
Advice for Trial Fitting .....	9
Alternative Slings for Lifting to and from the Toilet .....	10
Accessories .....	10
Overview Liko HygieneSling, Mod. 41 .....	10
Recommended Combinations .....	10

## Symbol Description

These symbols can be found in this document and/or on the product.

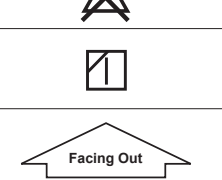
Symbol	Description
	Warning; this situation requires extra care and attention.
	Read instructions for use before use
	CE mark
	Legal manufacturer
	Date of manufacturing
	Product Identifier
	Serial Number
	Medical device
	Do not dry clean
	Do not iron
	Tumble drying
	Do not tumble dry
	Washing Symbol is always in combination with recommended temperature in °C and °F.
	Latex Free
	Periodic inspection
	Do not bleach
	Line drying in shade
	Direction upwards and symbol on outside of equipment.
	Symbol on outside of equipment.
	GS1 Data Matrix Barcode that may contain following information. (01) Global Trade Item Number (11) Production Date (21) Serial Number

# Safety Instructions

## Before lifting, keep the following points in mind:

- A responsible person within your organization should decide on a case-by-case basis whether one or more caregivers are needed.
- Ensure that the sling selected meets the patient's needs with reference to model, size, fabric and design.
- The total maximum load for a lift system is always determined by the product in the system with the lowest specified maximum load.
- For safety and hygiene reasons, use individual slings.
- Plan the lifting operation so that it can be done as safely and smoothly as possible.
- Check that the lifting accessory hangs vertically and can move freely.
- Although the Liko sling bars are equipped with latches, special caution must be exercised. Before the patient is lifted from the underlying surface, but when the straps are fully extended, make sure the straps are correctly connected to the sling bar hooks.
- Make sure the patient is sitting securely in the sling before transferring to another location.
- Never lift a patient higher off the underlying surface than is needed to complete the lifting and transfer procedure.
- Never leave a patient unattended during a lifting situation.
- Make sure that the wheels on the wheelchair, bed, gurney, etc., are locked during the lifting/transfer operation.
- Always work ergonomically. Use the patient's ability to actively participate in the operations.
- When the sling is not being used, do not place in direct sun light.
- It is recommended to remove the sling after the transfer.

 **Incorrect attachment of sling to slingbar may cause severe injury to the patient.**

 **Manually turning the patient in bed may cause injuries to the caregiver.**

 Medical Device Class I Product

**PATENT [www.hillrom.com/patents](http://www.hillrom.com/patents)**

**May be covered by one or more patents. See above Internet address.**

The Hill-Rom companies are the proprietors of European, US, and other patents and pending patent applications.

## **Product Changes**

Liko's products undergo continuous development, which is why we reserve the right to make product changes without prior notice. Contact your Hill-Rom representative for advice and information about product upgrades.

## **Design and Quality by Liko in Sweden**

Liko is quality certified according to ISO 9001 and its equivalence for the medical device industry, ISO 13485.

Liko is also certified according to environmental standard ISO 14001.

## **Notice to Users and/or Patients in EU**

Any serious incident that has occurred in relation to the device, should be reported to the manufacturer and the competent authority of the Member State in which the user and/or patient is established.

## Care and Maintenance

Check the sling before each use. Check the following points with regard to wear and damage:

- Fabric
- Straps
- Seams
- Suspension loops
- Buckle

**⚠ Do not use damaged lifting accessories.**

If anything is unclear, please contact the manufacturer or supplier.

**Washing Instructions:** Please see the sling's product label and the attached appendix "Care and Maintenance of Liko Slings".

### Periodic Inspection

The product must be inspected at least once every 6 months. More frequent inspections might be required if the product is used or washed more often than normal. See Liko's protocol "Periodic Inspection Liko Textile Products". For protocols please contact your Hill-Rom representative.

### Expected Life Time

The product has an expected life time of 1-5 years during normal use. Expected life time varies depending on the fabric, use frequency, washing procedure, and weight carried.

### Recycling Instructions

The entire product, including laths, padding material, etc. should be sorted as Combustible waste.

Hill-Rom evaluates and provides guidance to its users on the safe handling and disposal of its devices to aid in the prevention of injury, including, but not limited to: cuts, punctures of the skin, abrasions, and any required cleaning and disinfection of the medical device after use and prior to its disposal. Customers should adhere to all federal, state, regional, and/or local laws and regulations as it pertains to the safe disposal of medical devices and accessories.

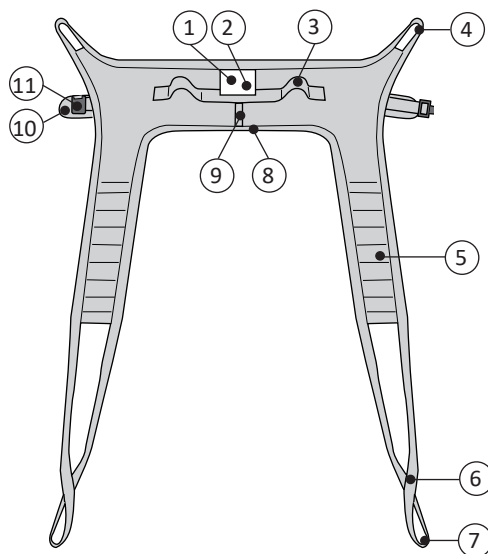

If in doubt, the user of the device shall first contact Hill-Rom Technical Support for guidance on safe disposal protocols.

## Definitions

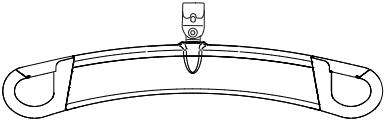
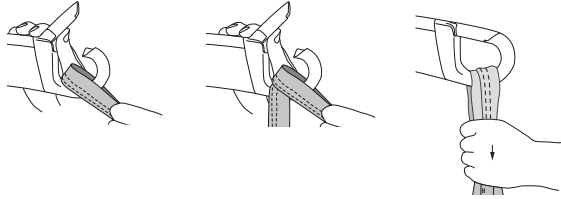
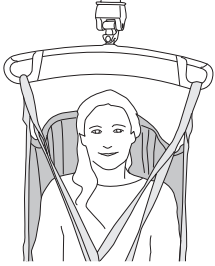
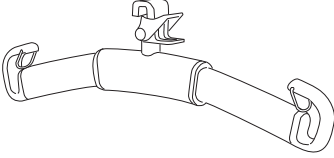
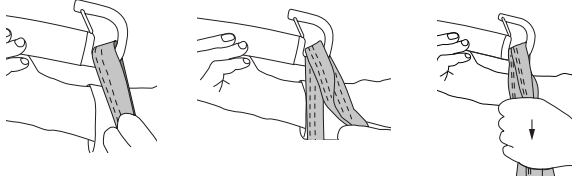

1. Product label
2. Serial number
3. Handle
4. Upper strap loop
5. Leg support
6. Shortening position
7. Outer leg support loop
8. Lower edge
9. Size marking
10. Belt
11. Buckle (*Tested of strength up to 200 kg (440 lbs.) by the supplier of the buckle*)

## How to Attach a Sling to Different Sling Bars

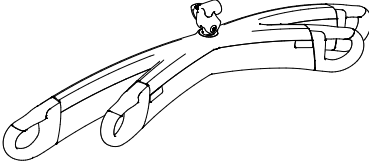
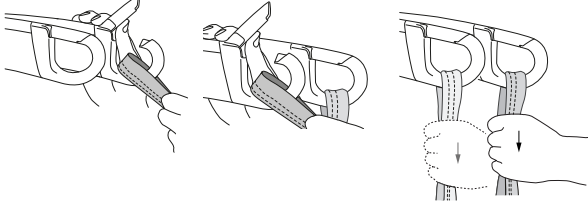
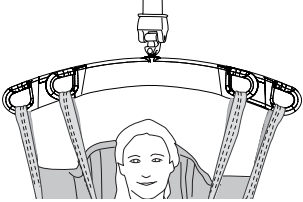
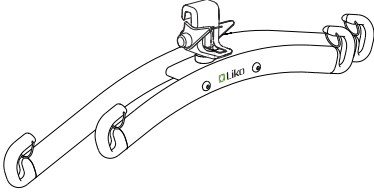
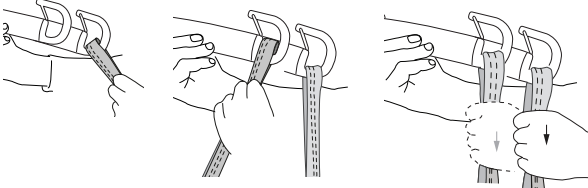
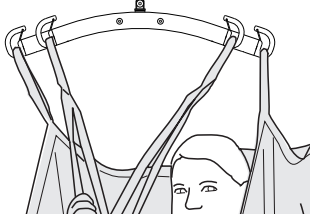
Sling bar	Sling loops to sling bar hooks	Correct
 <p>SlingGuard™</p>		
 <p>Universal</p>		
 <p>SlingGuard™ Twin</p>		
 <p>Universal Twin</p>		

### Wrong!

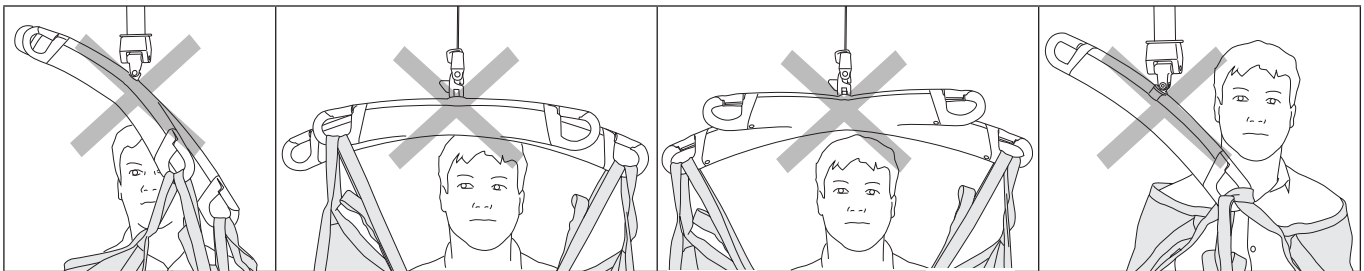

## How to Attach a HygieneSling to a Sling Bar with 4 Hooks (Twin Bars)

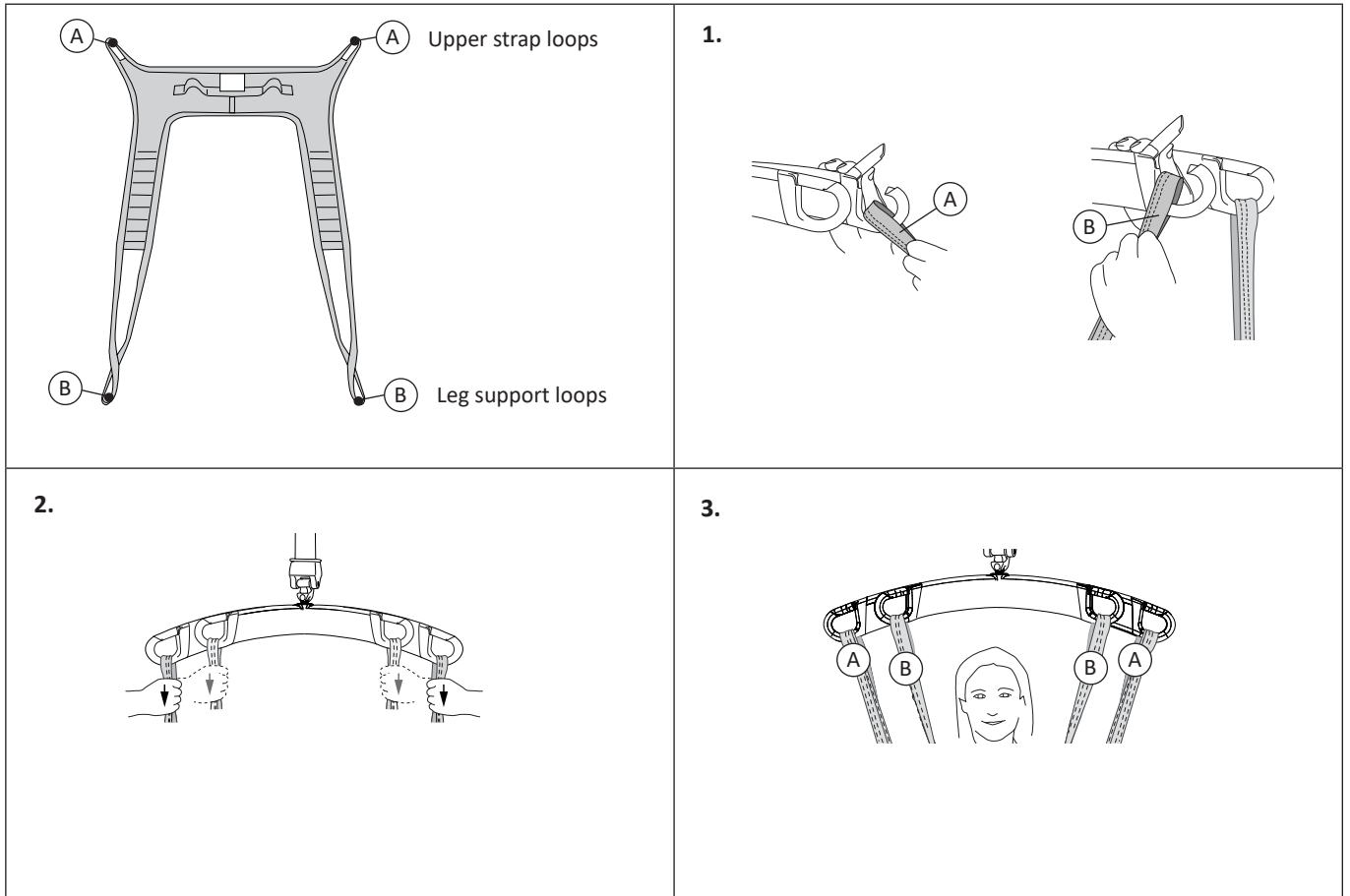

## Lifting from Wheelchair to Toilet

Prepare for the undressing sequence e.g. by unbuttoning buttons and loosening drawstrings.

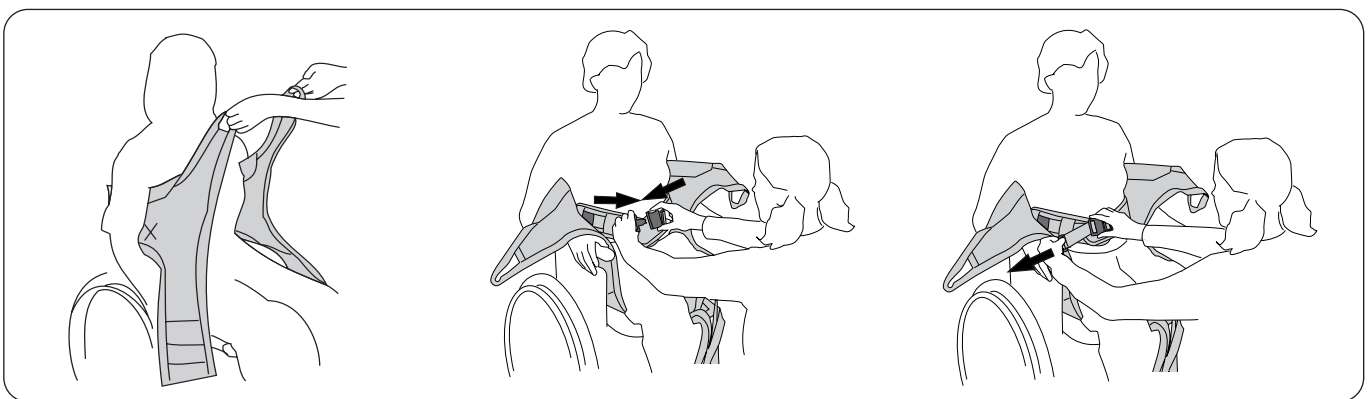

Place the HygieneSling with its product label at the center of the patient's back. The padded upper edge should be just under the armpits.

**⚠️ Arms on the outside!**

Buckle the belt.

Adjust the belt so that it fits around the patient's upper body.

**⚠️ Do not further tighten the belt once the patient has been lifted, since this can cause the patient to be strapped in too tightly once lowered.**

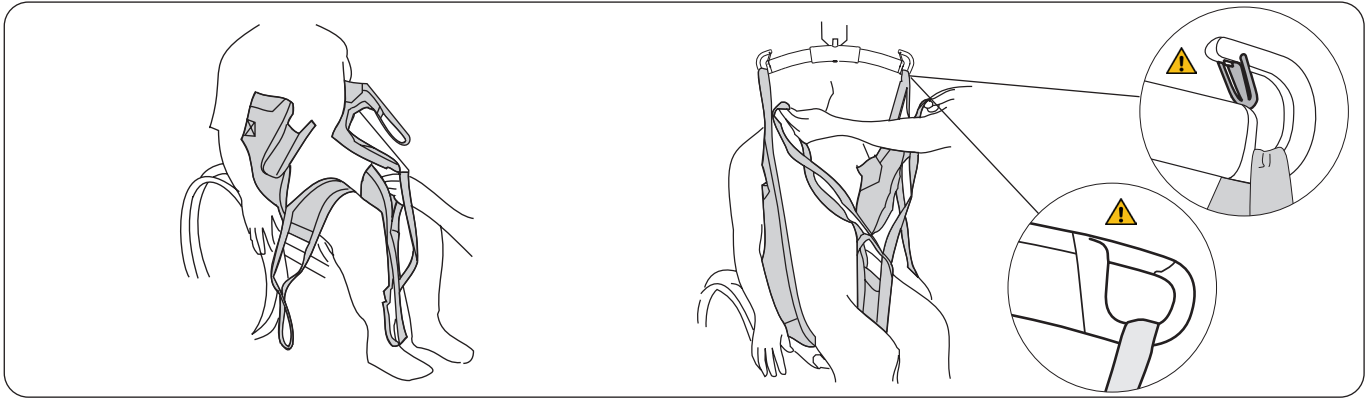

Place the leg supports under the patient's legs. Cross the leg supports by feeding one leg support loop through the other.

First connect the upper strap loops, then the leg support loops on the slingbar. See page 6-7 for instructions on how to attach the sling loops to different sling bars.

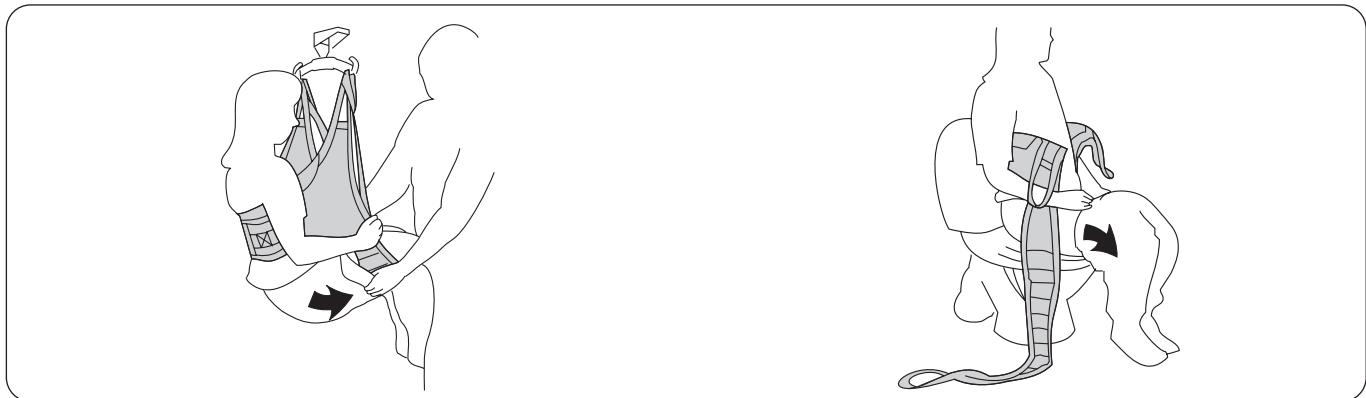

Lift the patient. Pull down the pants as far as possible.

Lower the patient onto the toilet. Fold away the leg supports and pull down the pants further for better accessibility.

## Returning from Toilet to Wheelchair

Following are two descriptions of how to put the clothes back on after a concluded toilet visit. The option you choose depends on the clothing and the physical state of the patient.

**Alternative 1:** Leg supports outside the pants. This is suitable for inelastic pants.

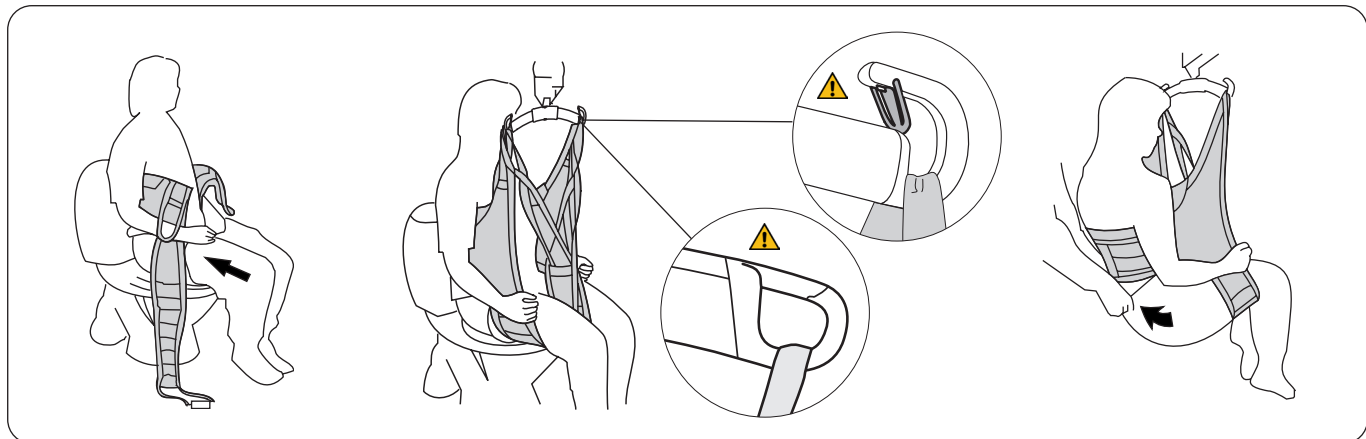

Pull up the pants as far as possible.

Place the leg supports under the legs but outside the pants.

**⚠️ Arms on the outside!**

First connect the upper strap loops to the slingbar, then the leg support loops. See page 6-7 for instructions on how to attach the sling loops to different sling bars. Lift the patient.

If needed, place an incontinence pad inside the pants before they are pulled into place over the buttocks. Perform the transfer and lower the patient into the wheelchair.



**Alternativ 2:** Leg supports first – pants outside. This method is suitable for elastic pants.

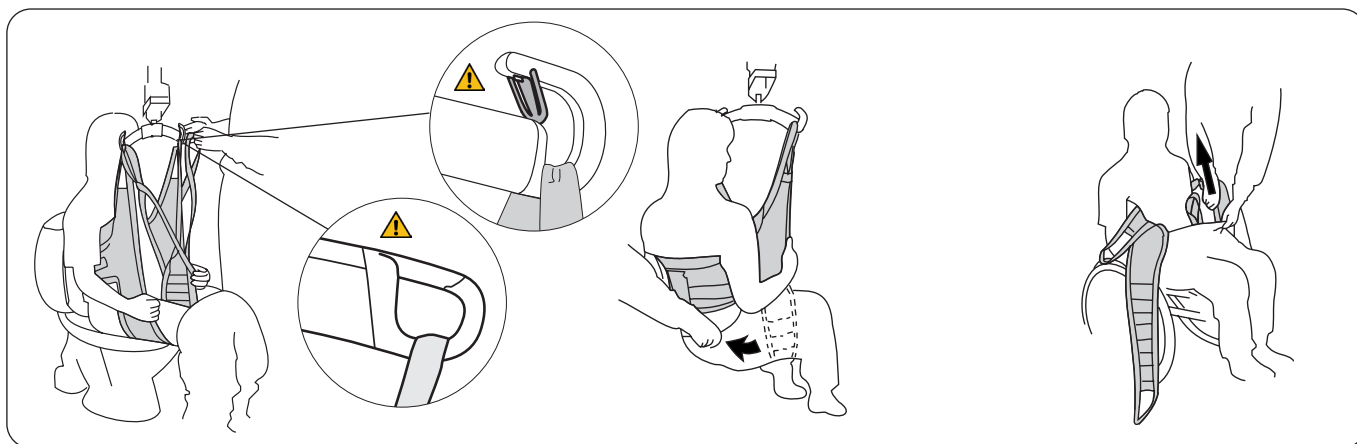

Place the HygieneSling on the patient according to the instructions on page 5. First connect the upper strap loops to the slingbar, then the leg support loops. See page 6-7 for instructions on how to attach the sling loops to different sling bars. Lift the patient.

If needed, place an incontinence pad inside the crossed leg supports.

Pull the pants up around the buttocks and sling when the patient has been raised and is still sitting in the HygieneSling. Lower the patient into the wheelchair.

Carefully work the leg supports out of the pants and remove the HygieneSling.

### Advice for Trial Fitting

**⚠** The sitting position depends on where the leg supports are placed under the patient's legs. For someone with poor muscle tone, they should be placed high up toward the groin so that he/she does not sit too low in the sling.

Patients with poor muscle tone usually sit better in a smaller HygieneSling size. For users with high muscle tone, the opposite applies. They sit better in a larger HygieneSling, provided that the back support is placed high enough and the leg supports are close enough to the bends in the knees.

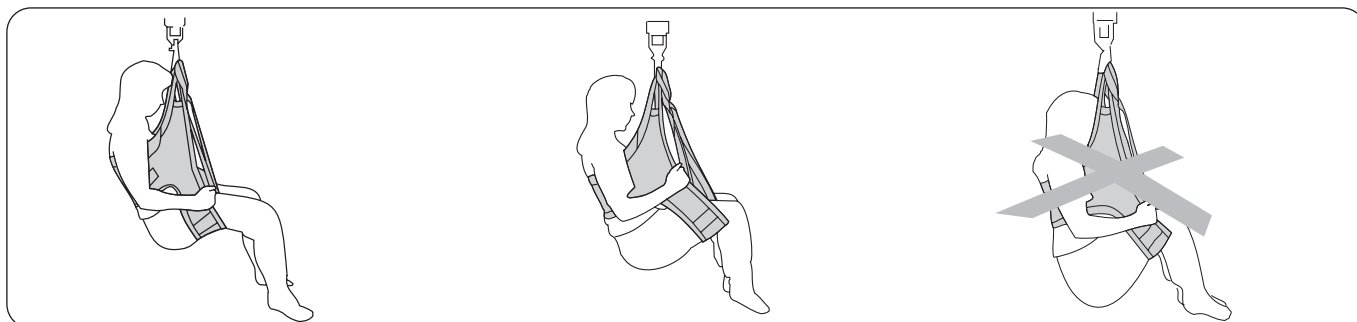

The leg supports should be placed as close to the groin as possible in most cases, especially on patients with very poor muscle tone. A smaller size can be advantageous in this case.

The leg supports can be placed closer to the bend in the knees for those with high muscle tone. This makes dressing and undressing easier and helps reduce spasticity. A larger size can be advantageous in this case.

A too low and uncomfortable seating position is due either to the leg supports being too close to the bend in the knees, or to the sling being too large. Try a smaller size.

### Shortening position

In certain cases, it is advantageous to shorten the leg supports for the patient to sit well in the HygieneSling. The shortening position can be used temporarily in order to test for the right length, yet extended use may damage seams. If you want to shorten the leg supports for long term use, it is recommended that you tie a knot into the leg support loop to shorten it about 10 cm (4 inch.). Then it is the outer leg support loop that should be connected to the slingbar.

## Alternative Slings for Lifting to and from the Toilet

In our wide selection of slings, there are many models that can be used for toilet-related lifting situations. Please visit [www.hillrom.com](http://www.hillrom.com) for more information. Following is a sampling of possible alternative slings:

- Liko HygieneSling with Safety Belt, Mod. 45
- Liko HygieneVest High Back, Mod. 55
- Liko MasterVest, Mod. 60
- Liko MasterVest with front closure, Mod. 64

### Accessories

- |                                     |                   |
|-------------------------------------|-------------------|
| Extension Loop, green, 12 cm (5 in) | Prod. No. 3691102 |
| Extension Loop, green 22 cm (9 in)  | Prod. No. 3691103 |
| Extension Loop, grey, 12 cm (5 in)  | Prod. No. 3691302 |
| Extension Loop, grey, 22 cm (9 in)  | Prod. No. 3691303 |

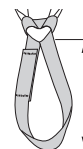

- 2 = 12 cm (5 in)  
- 3 = 22 cm (9 in)

## Overview, Liko™ HygieneSling, Mod. 41

Name	Prod. No.	Size		Patient's weight <sup>1</sup>	Maximum load <sup>2</sup>
Liko HygieneSling	3541133	XS	Extra small	< 30 kg (< 66 lbs.)	200 kg (440 lbs.)
Liko HygieneSling	3541134	S	Small	25-50 kg (55-110 lbs.)	200 kg (440 lbs.)
Liko HygieneSling	3541135	M	Medium	40-90 kg (88-198 lbs.)	200 kg (440 lbs.)
Liko HygieneSling	3541136	L	Large	80-120 kg (176-265 lbs.)	200 kg (440 lbs.)
Liko HygieneSling	3541137	XL	Extra large	> 100 kg (> 220 lbs.)	300 kg (660 lbs.)

<sup>1</sup> The indicated patient weight is a guideline only – there may be deviations.

<sup>2</sup> To maintain maximum load, lift/accessories intended for the same load or more are required.

**A size that is too large leads to risk of slippage; a size that is too small can cut into the groin and cause discomfort. See additional information under Advice for trial fitting, page 9.**

**Material:** HygieneSling is available in Polyester.

### Recommended Combinations

Recommended combinations of Liko HygieneSling and Liko slingbars:	Sling bars				
	Mini 220	Sling bars 350 <sup>3</sup>	Standard 450	Sling bars 450 <sup>1</sup>	Twin bars 670 <sup>2</sup>
HygieneSling Mod. 41, XS	1	1	2	2	4
HygieneSling Mod. 41, S	1	1	2	1	4
HygieneSling Mod. 41, M	1	1	1	1	4
HygieneSling Mod. 41, L	1	1	1	1	2
HygieneSling Mod. 41, XL	2	1	1	1	2

#### Explanation:

- 1 = Recommended
- 2 = May work
- 3 = Not advised
- 4 = Inappropriate

<sup>1</sup> Sling bars 450 relates to Universal SlingBar 450 Prod. No. 3156075, 3156085, and 3156095, and also SlingGuard 450 Prod. No. 3308020 and 3308520.

<sup>2</sup> Twin bars 670 relates to Universal TwinBar 670 Prod. No 3156077, and 3156087, and also SlingGuard 670 Twin Prod. No. 3308040 and 3308540.

<sup>3</sup> Sling bars 350 relates to Universal SlingBar 350 Prod. No. 3156074, 3156084, and 3156094.

Combinations of Liko HygieneSling and Cross-bar, Cross-bar 450/670 or Side bars are inappropriate.

### Other Combinations

Combinations of accessories/products other than those recommended by Liko can result in risks for the safety of the patient.



[www.hillrom.com](http://www.hillrom.com)

Liko AB  
Nedre vägen 100  
975 92 Luleå, Sweden  
+46 (0)920 474700

Liko AB is a subsidiary of Hill-Rom Holdings, Inc.

Enhancing outcomes for patients and their caregivers:

