

Propaq® LT Vital Signs Monitor



Directions for Use

901061 Patient monitor
Software version 1.60.XX

WelchAllyn®

Advancing Frontline Care™

© 2014 Welch Allyn. All rights are reserved. To support the intended use of the product described in this publication, the purchaser of the product is permitted to copy this publication, for internal distribution only, from the media provided by Welch Allyn. No other use, reproduction, or distribution of this publication, or any part of it, is permitted without written permission from Welch Allyn.

Welch Allyn assumes no responsibility for any injury to anyone, or for any illegal or improper use of the product, that may result from failure to use this product in accordance with the instructions, cautions, warnings, or statement of intended use published in this manual.

Welch Allyn, Propaq, Acuity, Smartcuf, and FlexNet are registered trademarks of Welch Allyn. ParamSet is a trademark of Welch Allyn.

Masimo, SET, LNOP, and LNCS are registered trademarks, and FastSAT and APOD are trademarks, of Masimo Corporation. Possession or purchase of a Masimo SpO₂-equipped monitor does not convey any express or implied license to use the device with unauthorized sensors or cables which would, alone or in combination with this device, fall within the scope of one or more of the patents relating to this device.

Nellcor and Oximax are registered trademarks of Nellcor Puritan Bennett.

Software in this product is copyright by Welch Allyn or its vendors. All rights are reserved. The software is protected by United States of America copyright laws and international treaty provisions applicable worldwide. Under such laws, the licensee is entitled to use the copy of the software incorporated with this instrument as intended in the operation of the product in which it is embedded. The software may not be copied, decompiled, reverse-engineered, disassembled or otherwise reduced to human-perceivable form. This is not a sale of the software or any copy of the software; all right, title and ownership of the software remain with Welch Allyn or its vendors.

For information about any Welch Allyn product, visit <http://www.welchallyn.com/about/company/locations.htm>.

DIR 80018709 Ver A



Welch Allyn, Inc.
4341 State Street Road
Skaneateles Falls, NY 13153 USA

EC REP

Welch Allyn Limited
Navan Business Park
Dublin Road
Navan, County Meath
Republic of Ireland

www.welchallyn.com



Contents

1 - Introduction	1
Intended use	1
Symbols	1
Safety	4
Controls, indicators, and connectors	8
Features and functions	10
Models	10
Accessories	11
USB option	11
HIPAA considerations	12
2 - Overview of monitor operation	13
Turning on the monitor	13
Selecting a language	14
About the charging/communications cradle	14
Displaying data	17
About navigation	31
Menus	33
About monitor information screens	38
Using demo mode	40
Power saving	44
Turning off the monitor	44
Communicating with an Acuity Central Station	44
About error detection	44
Transporting the monitor with the patient	45
3 - Standalone monitoring	47
Overview	47
Preparing for a new patient	47
Continuing to monitor a patient on power-up	51
Monitoring ECG and Resp	52
Monitoring SpO ₂	60
Monitoring blood pressure (NIBP)	65
Changing the default settings	69
To discontinue monitoring	71
4 - Monitoring in communication with Acuity	73
About wireless monitoring	73
Establishing communication with Acuity	74
Monitoring a patient outside of network range	75
About Acuity message menus	76
5 - Alarms and alerts	81
Overview	81
Silencing an alarm or alert tone	81
Suspending the alarm tone	82
Changing alarm limits	84

About ParamSet	85
Responding to an alarm	85
Responding to an alert	85
About battery charge status	86
Alert messages and status messages	87
6 - Storing and reviewing patient data	91
Overview	91
Capturing a data snapshot	91
Reviewing data at the monitor	92
Reviewing data at a PC	95
Reviewing data at Acuity	95
7 - Printing patient data	97
Overview	97
Printing	98
AutoPrint options	100
8 - Monitor configuration	103
Overview	103
About factory configuration	103
About default configuration	104
About temporary configuration	104
About Acuity-defined configuration	104
Parameter configuration matrix	105
9 - PC utility	113
Introduction	113
Installation	114
Using the Configuration Utility to configure the monitor	116
Configuration settings	118
About AutoPrint	121
Configuration worksheet	123
Identification	124
Default Settings	126
Display Settings	128
Mode Settings	131
ParamSet Settings	133
Feature Enable	135
Authorization	138
10 - Maintenance	139
Recharging the battery	139
Inspecting and cleaning the monitor and accessories	140
Recycling monitor components	141
A - Specifications	143
B - Compliance	159
Limited warranty	187
Index	189

1

Introduction

Intended use

The Propaq LT Series (802LTAN, 802LTAS, 802LT0N, 802LTRN, 802LT0S, and 802LTRS) monitors are portable devices intended to be used by clinicians and medically qualified personnel for single- or multiparameter vital-signs monitoring of ambulatory and nonambulatory patients, including neonate, pediatric and adult patients. These devices are indicated for ECG, noninvasive blood pressure (NIBP), respiration and SpO₂. The most likely locations for patients to be monitored by these devices are hospital general medical-surgical, telemetry, and intermediate care floors, hospital emergency departments, transport, emergency medical services, and other healthcare applications.

The monitors can be used as standalone devices or as devices networked to an Acuity[®] Central Station (referred to in this manual as 'Acuity') through wireless communication over a Welch Allyn[®] FlexNet[®] network.

Federal USA law restricts this device to sale, distribution, or use by or on the order of a licensed healthcare professional.

Even though this manual describes some monitoring techniques, the monitor is intended for use only by trained and experienced clinicians who know how to measure and interpret vital signs.

Symbols

Table 1. Directions for use



WARNING Indicates conditions that could lead to illness, injury, or death.



Caution In this manual, indicates conditions that could damage equipment or other property.



Caution On the product, means "Consult the accompanying documentation."

Table 2. Control buttons











Monitor	
	Power - Turn the monitor power on or off.
	Action - Act based on what is highlighted. (See "Using the action button" on page 31.)
	Left - Move the cursor left to the next display item; decrease the parameter value.
	Right - Move the cursor right to the next display item; increase the parameter value.
	Up - Move the cursor up to the next display item.
	Down - Move the cursor down to the next display item.
	Silence/Reset - Silence the current alarm tone for 90 seconds or reset a silenced alarm tone.
	Display - Cycle to the next configured display format, or cancel the current control, setup, or pop-up menu.
	Snapshot - Record a 21-second period of numeric and waveform data.
	Start/Stop NIBP - Start or stop an NIBP measurement.
Cradle	
	Monitor Release - Press and then hold while removing the monitor from the cradle.

Table 3. Status indicators

















Monitor	
	(green) Monitoring normally (no active alarms or alerts). Connection to Acuity is confirmed and patient identification is confirmed. (Wireless only, Acuity enabled.)
	(green flashing) Monitoring normally (no active alarms or alerts). (Standalone only.) Patient confirmed, and monitor then intentionally disconnected. (Wireless only, Acuity enabled.)
	(yellow) At least one alarm is disabled. Monitor disconnected, connecting or connected; patient not confirmed. (Wireless only, Acuity enabled.)
	(yellow flashing) Equipment alert. Acuity message windows. (Wireless only, Acuity enabled.)
	(red flashing) Patient alarm.
	Upper and lower alarm limits for this parameter are on.
	The upper alarm limit for this parameter is on and the lower is off.
	The upper alarm limit for this parameter is off and the lower is on.
	Upper and lower alarm limits for this parameter are off.
	A snapshot exists for this period.
	The snapshot for this period has been replaced with a more recent snapshot.
	(green) The battery is fully charged.
	The battery is partially full.
	The battery is partially full and is charging.
	(yellow) The battery is low.
	The battery is low and is charging.

Table 3. Status indicators (continued)













	(red) The battery is near failure; the monitor will shut down soon. If this indicator appears while the monitor is in the cradle, the battery cannot be charged and must be replaced.
	The battery is near failure and is charging. The monitor will shut down if removed from the cradle.
	The monitor is communicating wirelessly with the network and with Acuity. (Wireless only, Acuity enabled.)
	The monitor is not communicating with the wireless network. (Wireless only, Acuity enabled.)
	(Flashing) The monitor is communicating with the network but is not communicating with Acuity. (Wireless only, Acuity enabled.)
	The monitor is communicating by USB cable with a PC.
Cradle	
	(green) Cradle is powered.
	
	(green) Monitor battery is charging. NOTE: When the battery is fully charged, this indicator is not lit.
	
	(yellow) Cradle fault or battery fault.
	

Table 4. Labels

































Monitor			
	Proceed with caution. If in doubt, refer to the accompanying documentation.	IPX1	Enclosure protection: Drip-proof. Class IPX1 per EN60529:1991.
	The monitor or accessory meets all essential requirements of the European Medical Device Directive 93/42/EEC for a Class II-b product.		The monitor is certified by the Canadian Standards Association International to comply with applicable US and Canadian medical safety standards.
	The monitor or accessory meets all essential requirements of the European Medical Device Directive 93/42/EEC for a Class I product.		Type CF patient connections, isolated for direct cardiac application and protected against defibrillation.
	Australian registered importer.	IATA A45 ✓	Hazard Class 9, IATA/ICAO (International Air Transport Association/International Civil Aviation Organization).
R_x ONLY	Professional use only	FC	This device complies with the 47 CFR Part 15 radiated and conducted emissions requirements.
FCC ID: PGUWA11A07 IC:4168a-WA11A07	This device complies with FCC and Industry Canada requirements for international radiators (802.11 wireless).		
	See the accompanying manual.		Non-ionizing electromagnetic radiation. This device contains an approved RLAN module of frequency 5150-5825 MHz.
	Reorder number		Product identifier
	Recycle the monitor, cradle, and battery separately from other waste. (Refer to www.welchallyn.com/weee for collection-point and additional information.)		Non-ionizing electromagnetic radiation. This device contains an approved RLAN module of frequency 2402-2480 MHz. (Wireless only, Acuity enabled; see “EMC” on page 162.)

Table 4. Labels

	High voltage. Do not touch during defibrillation.		Direct current.
	Recycle the battery separately from other disposables.		Battery replacement specification.
	Lithium-ion battery.		This monitor (2.4 GHz) is approved for use during all phases of flight aboard U.S. Army aircraft. AWR: MIL STD: 461E. Army: CE101, CS101, T, CS115, S116, RE102, RE103.
	Rechargeable battery		
Cradle			
	12-28V=== 3A Power in (DC).		Fuse replacement specification.
	USB cable connector.		For indoor use only.
	Input power (DC) pin pattern.		
Product packaging			
	Store this way up.		Humidity limit.
	Temperature limits.		Altitude limits.
	Rain protection required.		Contents are fragile.
	Stacking limit.		Recycle the packaging material.

Safety

The monitor is safe for patients and clinicians when used in accordance with the instructions and with the warning and caution statements presented in this manual.

All personnel must read and understand all warning and caution statements presented in this manual before using the monitor.

- Failure to understand and observe any warning statement in this manual could lead to patient injury, illness, or death.
- Failure to understand and observe any caution statement in this manual could lead to equipment damage or loss of patient data.

General warnings

These statements apply to all aspects of patient monitoring. Statements which apply specifically to one aspect of monitoring, such as NIBP or SpO₂ monitoring, are presented in the corresponding sections of the manual.



WARNING Many environmental variables, including patient physiology and clinical application, can affect the accuracy and performance of the monitor. The clinician must verify all vital-signs information prior to patient intervention.

WARNING Always check the patient mode (adult, pediatric, or neonate) when monitoring a new patient. The patient mode determines default alarm limits and internal algorithm settings. Make sure the monitor has settings that are appropriate before monitoring the patient.

WARNING Make sure Acuity patients, and especially those prone to arrhythmias, are kept under close surveillance. While monitoring patients with Acuity, the clinician must review all clinical data *before* implementing therapy. As with all computerized arrhythmia analysis systems, Acuity cannot replace skilled care and proper surveillance by a clinician.

WARNING It is possible for Acuity alarms, alerts, or other events to go unnoticed if clinical personnel are not present at Acuity or if interruptions occur in power or system operations. To help reduce this possible occurrence, Acuity must be installed with redundant power supplies and redundant means of operator surveillance, such as secondary Acuity Central Stations and hallway message panels.

WARNING The monitor might not meet its performance specifications if stored or used outside the specified temperature and humidity ranges.

WARNING Use of respiration monitoring by impedance pneumography can affect the operation of some pacemakers. If pacemaker operation is affected, turn off respiration pneumography. (See [Figure 63](#) on page 57.)

WARNING Do not connect more than one patient to a monitor.

WARNING Do not connect more than one monitor to a patient.

WARNING During defibrillation, keep discharge paddles away from the monitor ECG lead wires, electrodes, any other monitor sensors, and other conductive parts in contact with the patient.

WARNING Do not operate this product in the presence of flammable anaesthetics or other flammable substances in combination with air or oxygen-enriched environments. Failure to observe this warning can result in an explosion.

WARNING Do not use the monitor in a Magnetic Resonance Imaging (MRI) suite or a hyperbaric chamber. Such use can cause fire or explosion resulting in patient injury and monitor damage.

WARNING Do not operate this monitor near equipment that emits strong electromagnetic or radio-frequency signals. Electronic equipment of this type can cause electrical interference with monitor operation, which can distort the ECG signal and prevent accurate rhythm analysis.



WARNING To comply with Federal Communications Commission (FCC) RF exposure requirements and to avoid exposure to radio-frequency (RF) radiation, always use the monitor in accordance with the operating conditions and instructions provided in this manual.

WARNING Pacemaker signals can differ from one pacemaker to the next. The Association for Advancement of Medical Instrumentation (AAMI) cautions that “in some devices, rate meters may continue to count the pacemaker rate during occurrences of cardiac arrest or some arrhythmias. Do not rely entirely upon rate meter alarms. All pacemaker patients should be kept under close or constant observation.” See “[Pacer pulse rejection](#)” on page 145 for disclosure of the pacemaker pulse rejection capability of this instrument.

WARNING Use only accessories approved by Welch Allyn. The use of any other accessories can result in inaccurate patient data, can damage the equipment, and can void your product warranty. Refer to the accessory list or www.welchallyn.com.

WARNING Always use accessories according to the standards of your facility and according to the manufacturer's directions.

WARNING Use of Masimo® LNOP® sensors/cables will not provide protection in accordance with IEC defibrillation standards when used with this device.

WARNING Use only ECG cables supplied or specified by Welch Allyn. Use of any other ECG cables can negate defibrillator protection and can create a risk of patient injury due to shock.

WARNING Frequently inspect—electrically and visually—all cables, sensors, and electrode wires. Replace any damaged cables, sensors or wires. Failure to properly inspect and keep in excellent working order all cables, sensors, and electrode wires can result in hazards to patients and to equipment failure and damage.

WARNING Always properly connect the electrosurgery return circuit. Improper circuit connection can cause current to return through monitor electrodes and probes, creating a burn hazard for patients.

WARNING Always keep patient motion to a minimum. Motion artifact can cause inaccurate measurement of patient vital signs.

WARNING Carefully route and secure patient cabling, using the supplied garment clips. Improperly routed and secured cabling can cause the patient to become entangled in the cables, creating a strangulation hazard.

WARNING When the patient is wearing the monitor or being transported by stretcher with the monitor connected, always take care to position the monitor carrying straps on the patient. Be certain that the straps do not and cannot cross the neck or throat and cause choking, and the straps do not restrict movement of the patient's arms or legs.

WARNING Never use a monitor that is not working properly. If the monitor is not working properly, patient waveforms might be inaccurate or might not be displayed.

WARNING If the monitor is damaged, or if you see any indication that the monitor is not operating properly, disconnect it from the patient. Do not return it to service until it has been inspected and, if necessary, repaired by qualified service personnel.



WARNING This wireless medical device was tested and, when used with a metal-free accessory between the monitor and the patient, complies with FCC RF Exposure (SAR) guidelines. The use of accessories containing metal may not ensure compliance with FCC RF exposure guidelines. Specific Absorption Rate (SAR) is a measurement of radio frequency energy. The FCC permits a maximum SAR value of 1.6 mW/g. The highest SAR value for this patient monitor, when worn by a patient in accordance with the directions for use, is 0.560 mW/g.

WARNING High-power radars are allocated as primary users of the bandwidth between 5.25 GHz and 5.35 GHz and between 5.65 GHz and 5.85 GHz. These radars can cause interference with this device and can damage this device.

WARNING Do not use the pulse oximeter as a replacement or substitute for ECG-based arrhythmia analysis.

WARNING The bedside patient monitor is the primary alarming source for the patient and a central station is a backup alarm source. The central station is only as reliable as its network and should be relied on only as a backup alarming device.

WARNING The leading cause of patient death or serious injury reported with the use of patient monitoring equipment is failure to respond to alarms notifying the user of an adverse change in patient condition. If you are relying on visual alarm notifications, maintain a clear line of sight and remain within 4 meters of the monitor or the central station. If you are relying on audio alarm notifications, make sure that you can hear audio alarms from where you are. Set the volume as needed considering the environment and ambient noise levels. Verify that the alarm is audible to a clinician working at the maximum distance from the monitor or central station.

WARNING Auto-reboots occur and wireless connection is occasionally disrupted. During this period, the bedside monitors continue to provide their primary alarming functions. Auto-reboots occur infrequently, due to poor environmental conditions. Failure to perform preventative maintenance can increase the frequency of occurrence.

WARNING False alarms may occur in some situations. You must understand and address the cause of the false alarms whenever possible to eliminate the possibility of repeated false alarms and alarm fatigue, which might result in a failure to respond to an actual alarm situation.

General cautions



Caution Do not autoclave the monitor.

Caution Autoclave accessories only if the manufacturer's instructions clearly direct you to do so. Many accessories can be damaged by autoclaving.

Caution Changes or modifications not expressly approved by Welch Allyn could void the purchaser's authority to operate the equipment.

Caution This product contains no user-serviceable components. Any unauthorized changes to the product invalidate Welch Allyn's warranty and also invalidate all applicable regulatory certifications and approvals.

Controls, indicators, and connectors

Figure 1. Controls

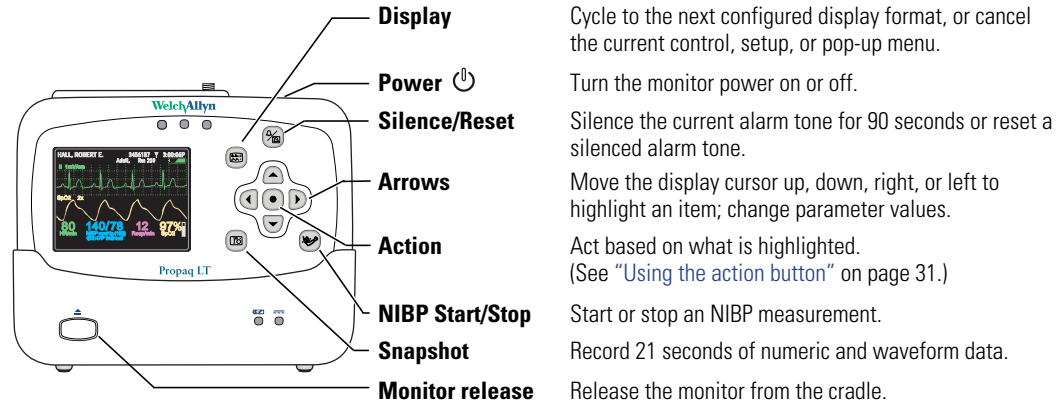

Figure 2. Indicators: Monitor

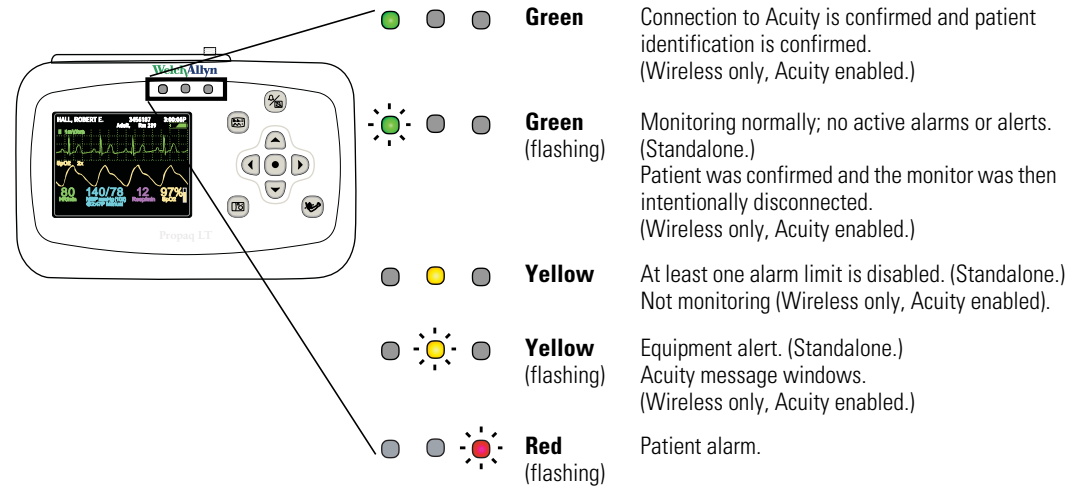

Figure 3. Indicators: cradle

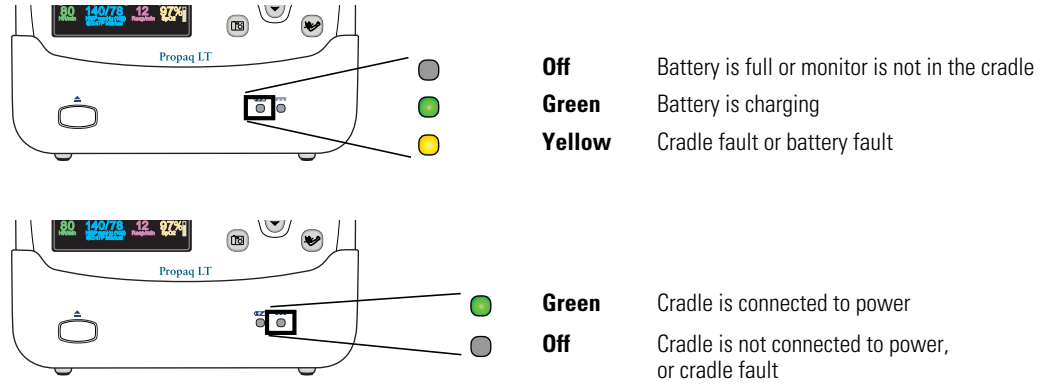

Figure 4. Connectors: monitor

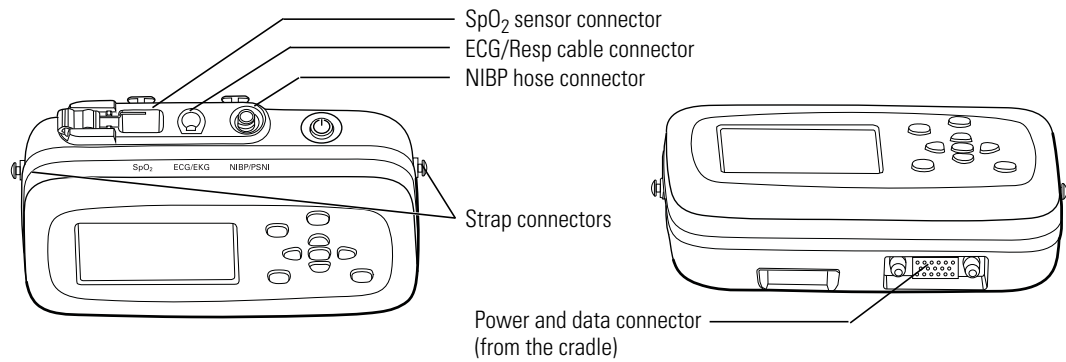
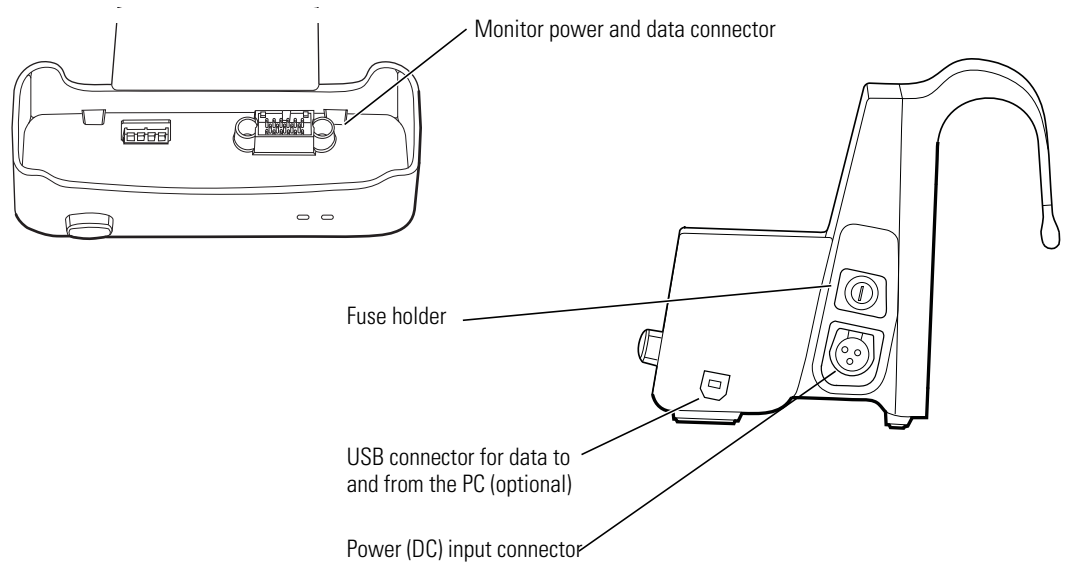

Figure 5. Connectors: cradle



Accessories

The following accessories are available for use with the monitor and the cradle:

- Large Color Display Interface and cables
- Propaq LT Monitor PC Utility software (CD)
- *Propaq LT Monitor Service Manual* (CD)
- *Propaq LT Monitor Directions for Use* (CD)
- Patient carry strap
- Patient wearable strap
- Transport stretcher strap
- Connector panel plugs
- SpO₂ cables and sensors
- 3-lead and 5-lead ECG cables and cable extensions
- ECG electrodes
- NIBP hoses and cuffs
- Battery pack
- AC power adapter



WARNING Use only accessories approved by Welch Allyn. The use of any other accessories can result in inaccurate patient data, can damage the equipment, and can void your product warranty. Refer to the accessory list or www.welchallyn.com.

WARNING Always use accessories according to your facility's standards and the manufacturer's recommendations.

For ordering information, contact Welch Allyn (see [page ii](#)).

USB option

The monitor can be purchased with the optional USB data transfer capability, which enables communication between the monitor and a PC. (See "[About the USB data transfer option](#)" on page 15.)

HIPAA considerations

Each medical facility is responsible for creating and enforcing policies and procedures to guarantee compliance with the regulations defined in 45 CFR 160-164 of the Health Insurance Portability and Accountability Act (HIPAA) of 1996.

The Propaq LT Monitor, the Large Color Display Interface, the Propaq LT Monitor Configuration Utility, and the Propaq LT Monitor AutoPrint Utility incorporate security features that support your implementation of the HIPAA requirements for ensuring that patient information is kept private and confidential.

Monitor

- Clinicians can lock the monitor display to prevent the display of patient vital signs. For patient protection when the monitor display is locked, the display is restored instantly in the event of a button press (unless button-pad lock-out is enabled), an alarm or an alert.
- Clinicians can lock the monitor buttons to prevent any unauthorized access to the monitor controls. To protect the patient when the buttons are locked, access to the buttons is restored instantly in the event of an alarm or an alert.
- No physiological data transmitted by radio from the monitor is in clear text. All data sent is encoded using Welch Allyn's proprietary PSI Communications Protocol and can only be decrypted by a Welch Allyn Acuity Central Station residing on the local Welch Allyn FlexNet network. By default, data transmitted using the 802.11a standard is also encrypted using AES (Advanced Encryption Standard).

Configuration utility

The Configuration Utility never contains patient data.

AutoPrint utility

- All patient data is stored in a Welch Allyn proprietary data format which is readable only by machine.
- All patient data is deleted from the PC when it is sent to the printer.

2

Overview of monitor operation

Turning on the monitor

The monitor runs through an operational self-test each time it is powered on. Always verify that it follows the power-on sequence shown below. When [Step 3](#) completes as described, the monitor has verified that the visual and audible alarm indicators are working properly. If [Step 4](#) does not complete as described, remove the monitor from service and have it examined by a qualified service person.

To turn on the monitor

1. Press and hold  until a tone sounds.
2. A tone sounds as the green, yellow, and red lights turn on and off. This occurs twice.
3. The splash screen appears, identifying the product and displaying the message “Diagnostics in progress”. The green light turns on and off quickly while the low tone sounds, the yellow light turns on and off quickly while the medium tone sounds, and the red light turns on and off quickly while the loud tone sounds.

Figure 6. Splash screen



4. The splash screen is replaced by one of the power-on screens shown here:

Figure 7. Power-up screens

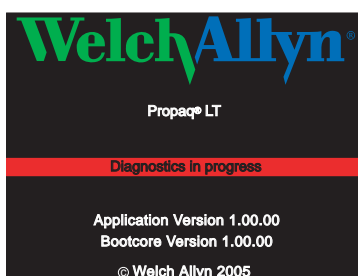
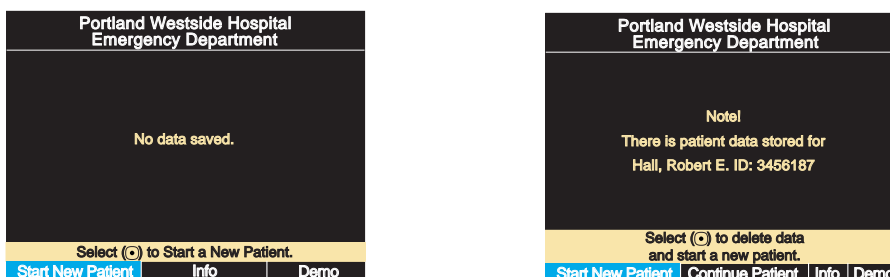

To start monitoring from this point, see “[Standalone monitoring](#)” on page 47. To practice using the monitor, see “[Using demo mode](#)” on page 40.

Selecting a language

To change the language of the monitor interface











1. If the monitor power is on, press  to turn it **off**.
2. Press  to turn the monitor power **on**.
3. Immediately after pressing , and before any screen appears, simultaneously press  and . Keep the buttons pressed until the language selection screen appears.

Figure 8. Language selection screen



4. Press , , , and  to highlight the language you wish to use.
5. Press .

Power-on continues in the selected language.

Note If you select **French**, HR/PR alarm limits cannot be turned off unless you go through the service menus to change this setting. If you do change this setting, the change stays in effect through power cycles.

For information about using the service menus, refer to the *Propaq LT Monitor Service Manual* (810-1811-XX).

The monitor always powers on in this language until the setting is changed again. The setting can be changed again only if one of the following occurs:

- This procedure is repeated.
- A new configuration is downloaded from a PC. (See [“Using the Configuration Utility to configure the monitor”](#) on page 116).
- A new configuration is downloaded from Acuity.

About the charging/communications cradle

When the charging/communication cradle (the **cradle**) is attached to AC power (or to vehicle DC power) and the monitor is seated in the cradle, the cradle does the following:

- Recharges the monitor battery, whether patient monitoring is occurring or not.
- Powers the monitor, conserving the charge on the monitor battery.
- (If the cradle has the USB data transfer option) enables data transfer between a PC and a monitor. See [“About the USB data transfer option”](#) on page 15.



WARNING Never download a configuration file to the monitor while you are monitoring a patient with the monitor in the cradle.

- Communication with the network (and Acuity) is interrupted if you download a configuration to the monitor or upload patient data from the monitor.
- Changing the monitor configuration shuts down the monitor and deletes all patient data from the monitor.

Figure 9. Monitor and cradle

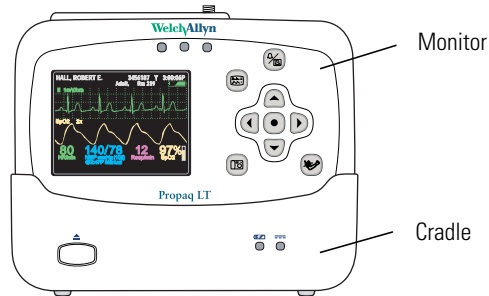

The cradle is intended to hold the monitor when the patient is in bed or is otherwise stationary. The cradle can sit on a flat surface near the patient or attach to the bed rail (using the bed-rail hook).

If the monitor is in the cradle and the AC power adapter is connected to the cradle, the monitor runs on AC power rather than battery power. This keeps the monitor battery at full charge so that the monitor can then run on battery power when it is removed from the cradle to accompany the patient away from the bed.

The cradle can be connected to AC power at all times, whether the monitor is present or not.

About the USB data transfer option

A cradle configured with the optional USB communication port and connected to a PC with the Propaq LT Configuration Utility and the Propaq LT AutoPrint Utility can be used for the following:

- Creating custom monitor configurations on the PC and downloading them to any number of monitors. (See “[Monitor configuration](#)” on page 103.)
- Uploading the configuration file from the monitor to the PC.
- Uploading patient data from the monitor to the PC for printing. (See “[Printing patient data](#)” on page 97.)

Setting up the cradle

1. Place the cradle on a table or shelf, or hang it on a bed rail.



WARNING Place the cradle so that it cannot fall on the patient.



Caution Locate the cradle near the patient but not so close that it interferes with patient care.



2. Connect the AC adapter to an AC power outlet and to the cradle. The indicator  (green) on the front of the cradle indicates that the AC power adapter is connected.

Figure 10. Cradle status indicators

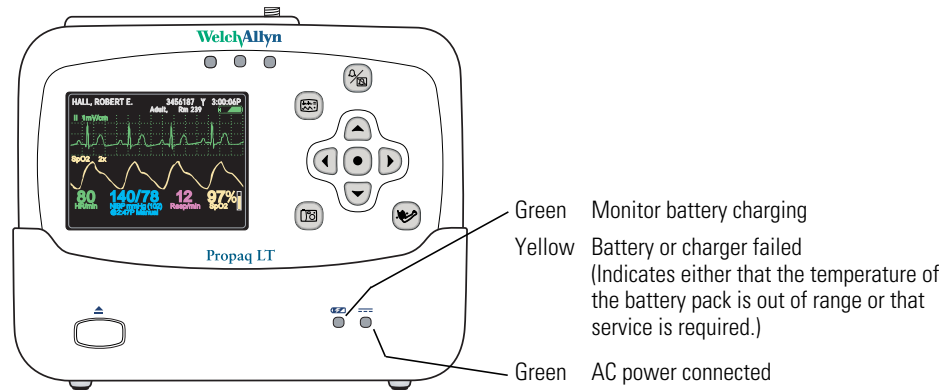

3. Insert the monitor into the cradle. When the monitor is properly seated, it clicks into place.  (green) on the cradle indicates that the monitor battery is charging. (See "Recharging the battery" on page 139.)

Note The monitor can be inserted into the cradle when power is on or off. If monitor power is on, inserting the monitor in the cradle or removing the monitor from the cradle does not interrupt patient monitoring.

Removing the monitor from the cradle

To remove the monitor, depress the release button on the front of the cradle. With the button depressed, hold the cradle securely with one hand, grasp the monitor firmly with the other hand, and lift the monitor out.

Figure 11. Monitor release button

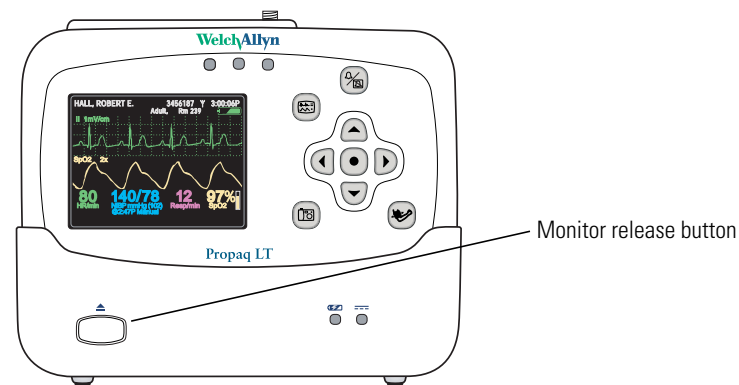

Displaying data

Patient vital signs appear on the 3.5-inch (diagonal measurement) monitor display and optionally on the Large Color Display screen.

Figure 12. Components of the vital-signs display (A)

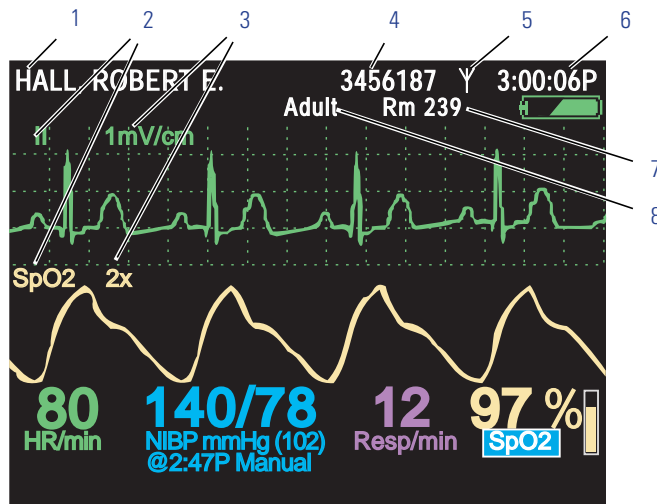





-
- | | |
|---|------------------------------------------------------------------------------------------------------------------------------------------------------------------------------------------------------------|
| 1 | Patient name (if available) |
| 2 | Waveform source |
| 3 | Waveform display scale |
| 4 | Patient ID (if available) |
| 5 | Connection status icon |
| | (blank) Connectivity not enabled. |
| |  The monitor is communicating via USB cable with a PC. (Wireless monitor only, Acuity enabled.) |
| |  The monitor is communicating with the network and with Acuity. (Wireless monitor only, Acuity enabled.) |
| |  Flashing — the monitor is communicating with the network but not with Acuity. (Wireless monitor only, Acuity enabled.) |
| |  Steady — the monitor is not communicating with the network. (Wireless monitor only, Acuity enabled.) |
| 6 | Time of day |
| 7 | Patient room number |
| 8 | Patient mode |
-

Figure 13. Components of the vital-signs display (B)

-
- 9 Battery status (See Table 3, “Status indicators” on page 2.)
- green partially to fully charged
 - yellow nearly discharged
 - red discharged; the monitor will shut down soon
- 10 Color-coded waveforms, ECG Lead identifiers, and vital-signs numerics
- Green ECG and HR/PR
 - Cyan NIBP
 - Purple Resp
 - Yellow SpO₂
- 11 SpO₂ pulse amplitude
- 12 SpO₂ numeric data
- 13 Respiration rate numeric data
- 14 NIBP numeric data
- 15 HR (heart rate) is displayed if ECG is active.
PR (pulse rate) is displayed if ECG is not active and SpO₂ or NIBP is active.
The monitor indicates an HR/PR measurement outside the measurable range as follows:
- out-of-range low
 - +++ out-of-range high
 - ??? undetermined
-

About display formats

The monitor can be configured to display any of these formats:

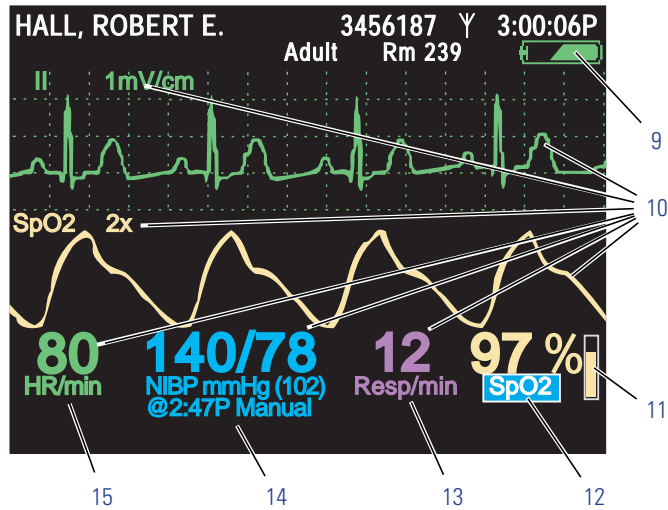
Table 5. Display formats

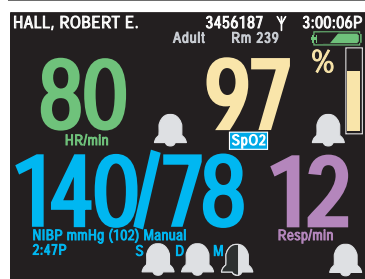

Large numerics

Blood pressure, heart rate, respiration rate, and SpO₂ measurements displayed in large numerics.

Bell icons indicating...

Left half	Lower alarm limit
Right half	Upper alarm limit
White	Alarms enabled
Black	Alarms disabled

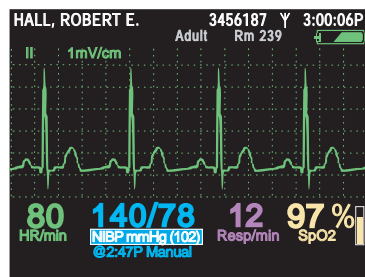

Single waveform

- 3 seconds of one ECG or SpO₂ signal or ...
- 12 seconds of the Resp signal.

Vital signs displayed in medium-sized numerics.

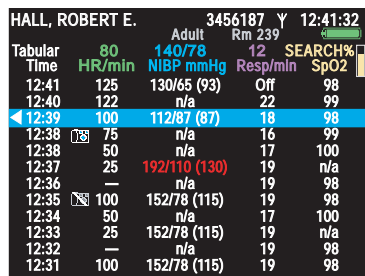

Tabular trends

Current vital signs displayed above the table in small numerics.

Historical vital signs displayed in a table.

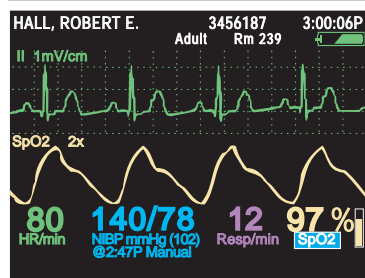

Dual waveform

- 6 seconds of an ECG or SpO₂ signal or 24 seconds of the Resp signal or...
- Any two of the following: 3 seconds of an ECG or SpO₂ signal and 12 seconds of the Resp signal.

Other vital signs displayed numerically below the waveforms.

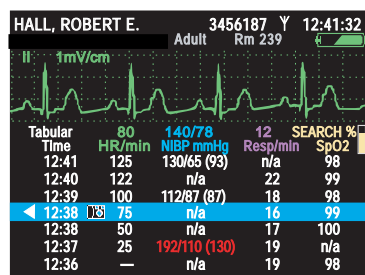

Tabular trends with single waveform

- 3 seconds of an ECG or SpO₂ signal or...
- 12 seconds of the Resp signal.

Other vital signs displayed numerically below the waveforms.

Historical vital signs displayed in a table below the waveform.





The monitor can be configured to cycle quickly through three of the five available display formats when you press . For example, if the configuration specifies three formats—**Large Numerics**, **Single Waveform**, and **Tabular Trends**—you can press  repeatedly to cycle through those formats.

Figure 14. Cycling through the configured display formats

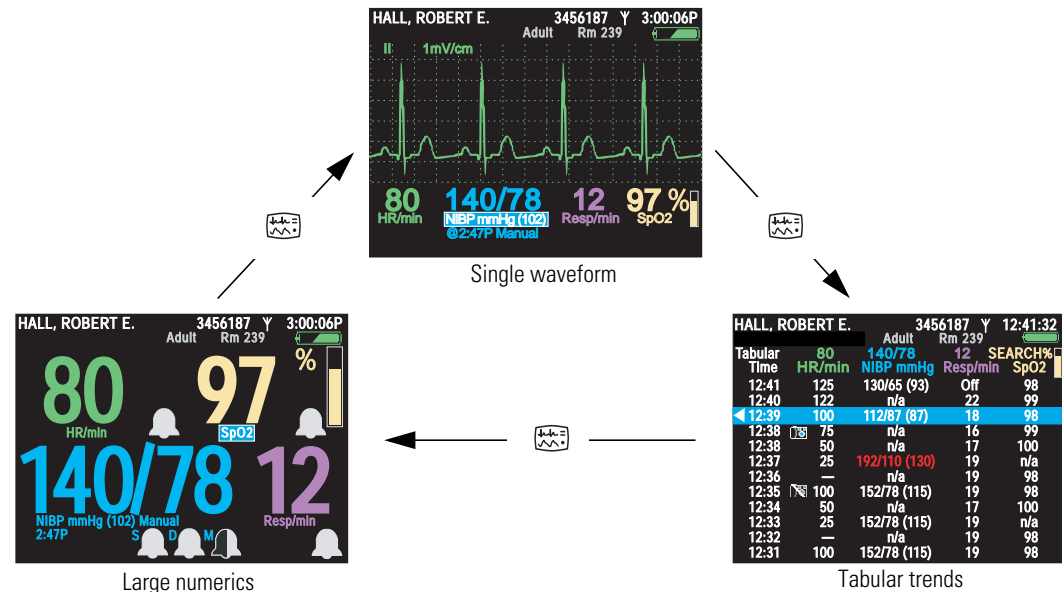

Certain properties of each display type can also be configured. See “[Display Format](#)” on page 129.

To view a tabular display if no tabular trends format is specified

1. Access the **Setup** menu. (See “[To access the setup menus](#)” on page 37.)
2. Highlight **Trends** and press .

Note All valid display configurations include at least one waveform format.

Timing out the display and the back light

To conserve battery run life, the monitor display and the back light can be configured to turn off if no operator activity (that is, a button press) is detected for a specified number of minutes.

- When the display is off, no patient data is visible.
- When the back light is off, patient data is visible only under direct light.

Note If the display and the back light are turned off due to a time out, they turn on again immediately when an alarm or alert occurs or, if the buttons lock-out is not enabled, when you press any monitor button.

The monitor configuration determines whether the time-out feature is enabled or disabled, and defines the default time-out period if it is enabled. If the feature is enabled in the configuration, you can temporarily change the time-out period or disable the time out through the Setup -> Timings menu.

Locking out the display, back light, and buttons

If lock-outs are enabled, you can lock out one or more of the following elements:

Buttons To prevent unauthorized use

Back Light To extend the battery run life

Display To prevent unauthorized viewing of patient information

The monitor configuration defines which of these, if any, can be locked out. For information on enabling or disabling lock-outs for these elements, see “[Monitor configuration](#)” on page 103.

To lock out the configured elements

Hold down ▲, ▼, and ▶ simultaneously for 5 seconds.

To unlock the configured elements

Hold down ▲, ▼, and ▶ simultaneously for 5 seconds.

Note Alarms and alerts immediately unlock any locked elements.

Large color display interface

Using the Large Color Display Interface (‘interface box’) optional accessory, you can display patient vital signs from the monitor on a full-size screen. It receives video signals from the cradle via a VGA cable.



WARNING All signal input and output (I/O) connectors are intended for connection of only devices complying with IEC 60601-1, or other IEC standards (for example, IEC 60950), as applicable to the monitor. Connecting additional devices to the monitor may increase chassis or patient leakage currents. To maintain operator and patient safety, consider the requirements of IEC 60601-1-1. Measure the leakage currents to confirm that no electric shock hazard exists.

Large color display configuration options

- If the interface box is mounted on the large screen ([Figure 15](#)), the screen must be within about 3 meters of the cradle.
- If the interface box is mounted on the cradle ([Figure 16](#)), the distance between the box and the screen is limited by the length of the VGA cable.
- If the interface box, the cradle, and the large screen are mounted together ([Figure 17](#)), the distance from them to the patient’s bed is limited by the length of the SpO₂ sensor cable, the ECG cable, and the NIBP air hose (whichever is shortest).



Caution If you require medical-grade protection against leakage current, install an approved power conditioner between the large color display power cable and the mains power.

Note The various configurations are not interchangeable. Each requires a unique combination of screws, USB and power cables, and VGA cable.

Note If the interface box is attached to the cradle, the bed rail hook cannot be used.

Figure 15. Interface box mounted on the large screen

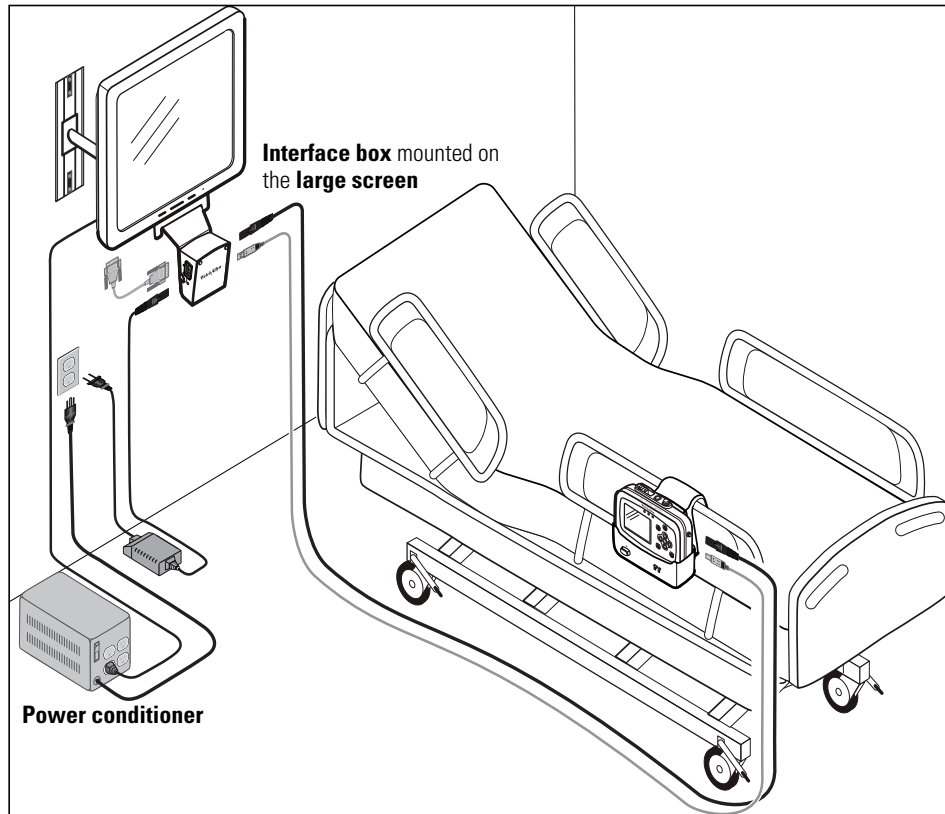

Figure 16. Interface box mounted on the cradle

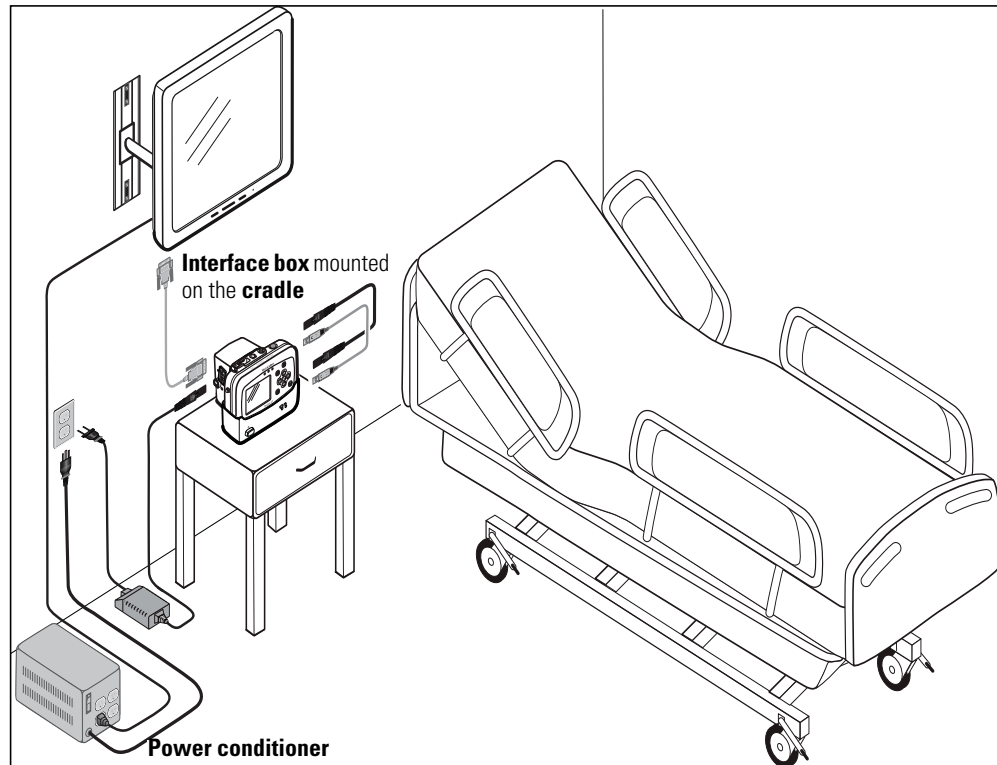
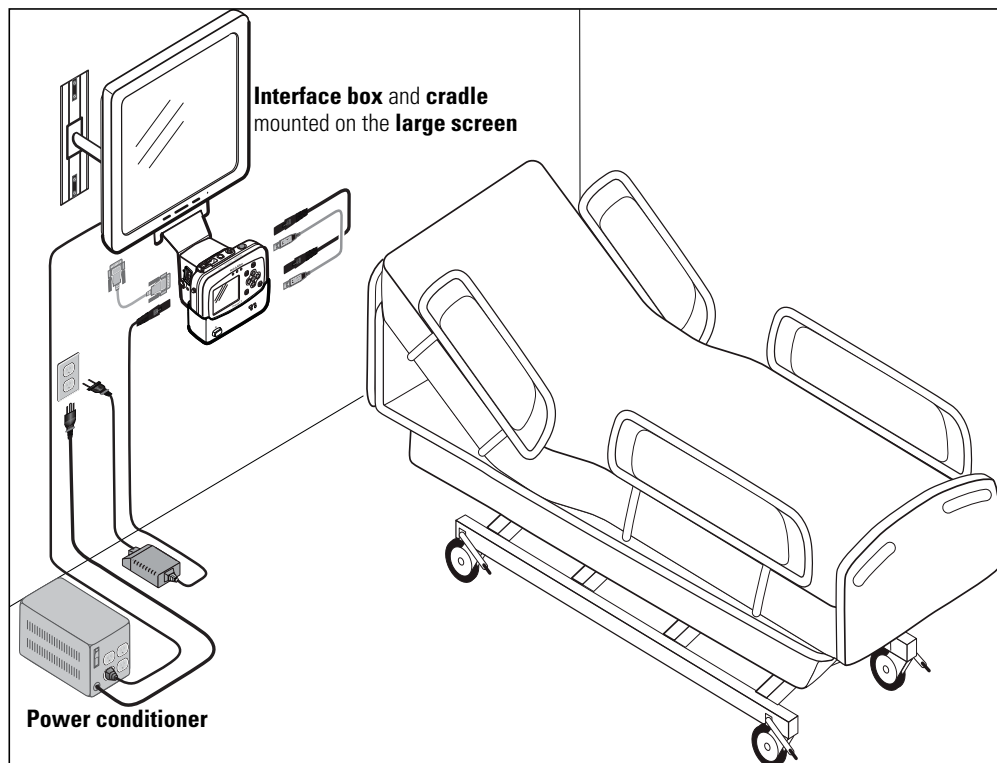

Figure 17. Interface box and cradle mounted on the large screen



Large display viewing options

The large display shows vital signs numerics and either four or nine waveforms.

Figure 18. Large color display viewing options

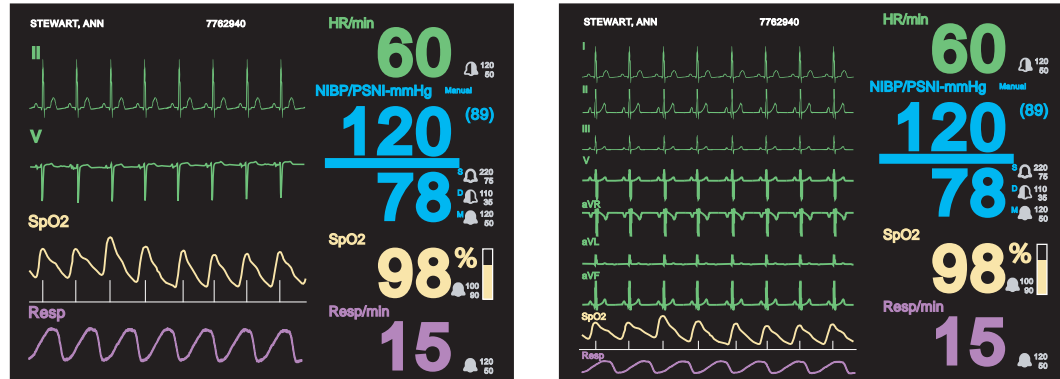

To change between 4-waveform and 9-waveform views, insert a wire into the small hole in the interface box near the USB connector, or press the button.

If you change the display format at least 15 seconds before shutting off power to the interface box, the newly selected display becomes the default display when the interface box is next powered on.

Figure 19. Switching between the 4-waveform and 9-waveform views

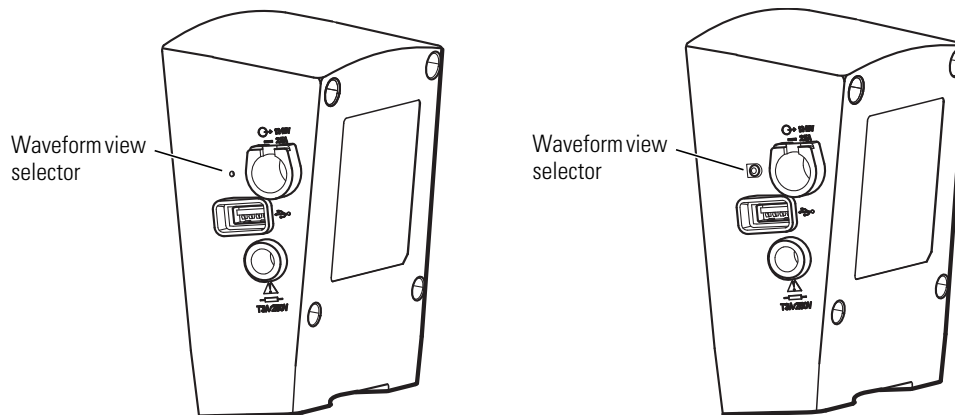

Determining what appears on the large display when using a 3-lead ECG cable

Figure 20. 4-waveform view, 3-lead cable



Leads I, II, and III are viewable. The waveform for the lead selected at the monitor is displayed on the large color display. Lead V cannot be displayed.

Note When using a 5-lead cable with all electrodes attached, only leads II and V are available in the 4-waveform view.

Figure 21. 9-waveform view, 3-lead cable



Leads I, II, and III are viewable. The waveform for the lead selected at the monitor is displayed on the large color display. Leads V, aVR, aVL, and aVF cannot be displayed.

Note When using a 5-lead cable with all electrodes attached, leads I, II, III, V, aVR, aVL, and aVF are available in the 9-waveform view.

Installing the interface box

The Large Color Display Interface receives DC power from the AC power adapter and vital-signs data from the cradle. It provides DC power to the cradle and the video signal to the large display.

Figure 22. Interface box connections

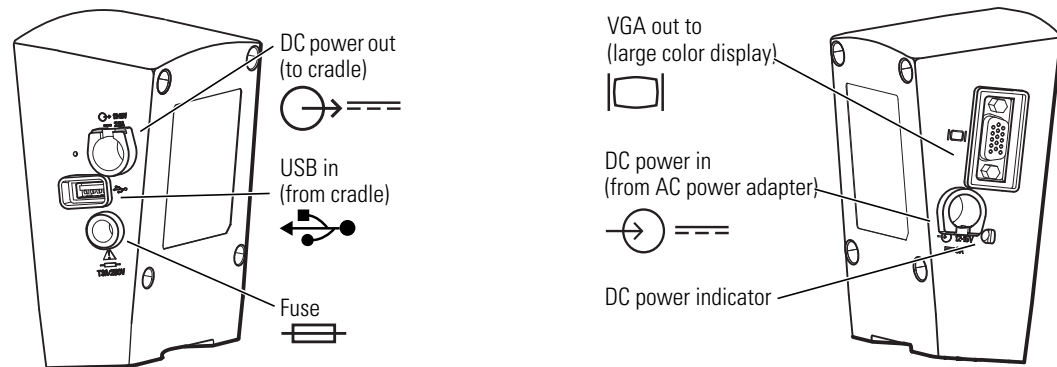

When the interface box is attached to the cradle, the default power and USB cables connect the interface box and the cradle. (See [Figure 17](#) on page 23.)

If the interface box and the cradle are not attached, longer cables are used.

The AC power adapter is shipped with the cradle.

Note The AC power adapter used with the Propaq CS monitor or the Propaq Encore monitor will **not** power the interface box.

When the interface box is not used, the AC power adapter is attached to the cradle. When the interface box is used, the AC power adapter is connected to it and not to the cradle.

Detaching the bed rail hook from the cradle

If you are attaching the interface box to the cradle and if the cradle and the bed rail hook are attached, you must first detach the bed rail hook from the cradle.

1. Remove the screws from the back of the bed rail hook.
2. Lift the bed rail hook off of the shoulder screws on the back of the cradle.
3. Remove the shoulder screws from the back of the cradle.

Figure 23. Detaching the bed rail hook from the cradle

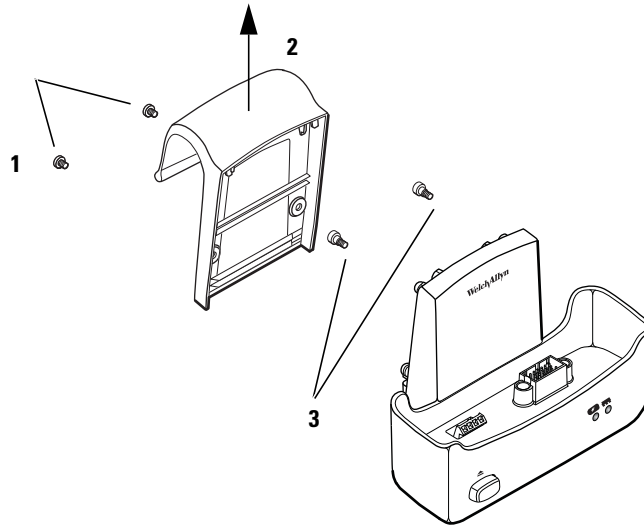

Assembling the large color display

Refer to [Figure 24](#), [Figure 25](#) on page 29, or [Figure 26](#) on page 30.

Figure 24. Mounting the interface box (with face plate) on the large display mounting bracket

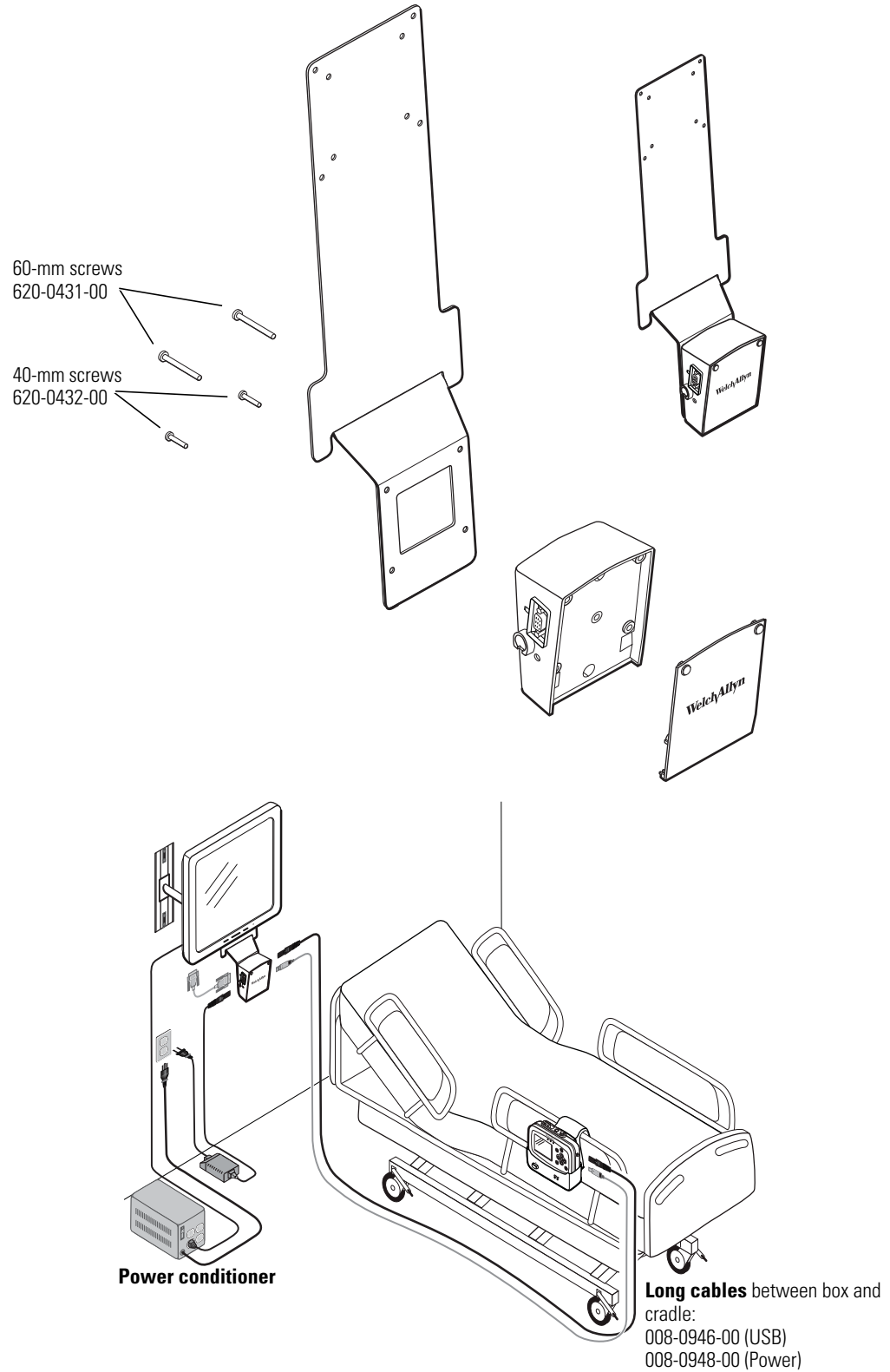

Figure 25. Mounting the interface box on the cradle

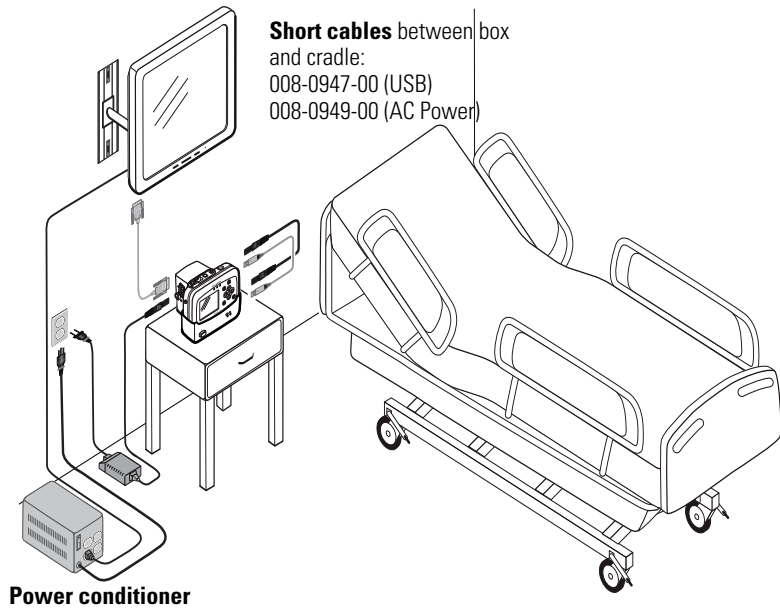
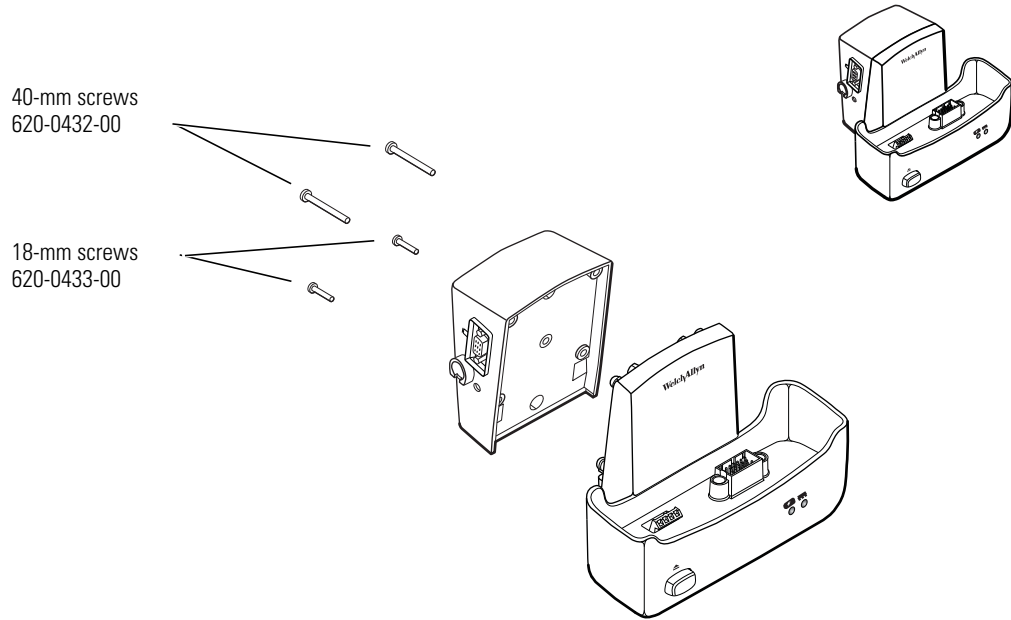
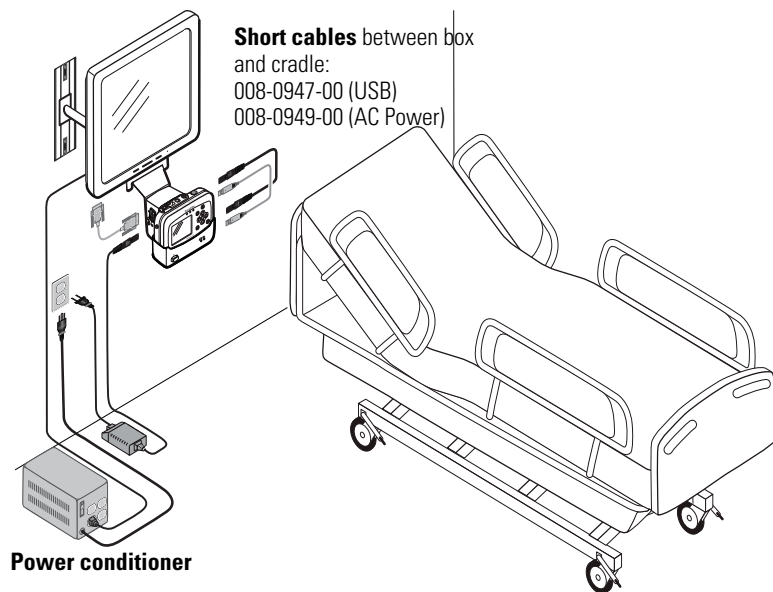
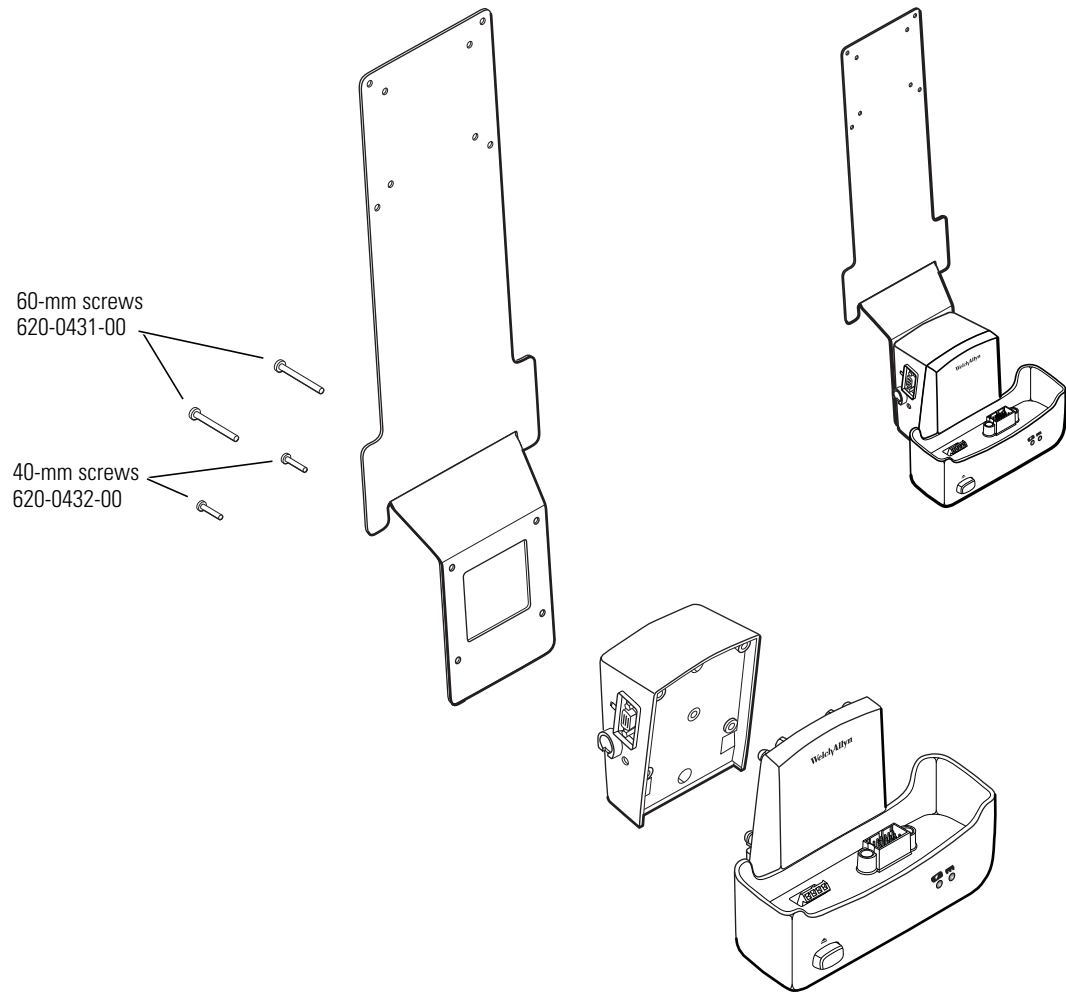

Figure 26. Mounting the interface box and the cradle on the large display mounting bracket



About navigation

You navigate the monitor screens using ▲, ▼, ◀ and ▶ (arrow buttons), ● (action button), and  (display button).

Using the arrow buttons

Use ▲, ▼, ◀ and ▶ to do the following:

- Highlight an item on the display. (See “Using the highlights” on page 31.)
- Select options from a control menu.
- Use ▲ and ▼ to select options from a pop-up menu.
- Use ◀ and ▶ to change the values of numeric parameters.

Using the action button

Use ● to do the following:

- Display the control menu for a blue-highlighted item.
- Return from a control menu to the primary display.
- Access the Setup menu when Setup is highlighted.
- Display tabular and graphical trends when Trends is highlighted.
- Display snapshots when Snapshot is highlighted.
- Turn on the display or the back light if either has been turned off by a time-out.
- Display a pop-up menu.

Using the display button

Use  to do the following:

- Cycle through the configured display formats.
- Return from a control menu to the primary display.
- Close a pop-up menu.

Using the highlights

Every screen contains a single element—the current context—highlighted by a blue field. Some screens also contain elements—parameter values—highlighted by a green field.

About blue highlights

A **blue highlight** identifies the **current context**. For example, [Figure 27](#) illustrates a highlighted **row** in a trends display and a highlighted **setting** in the Waveform Size menu.

Figure 27. Examples of highlighted elements

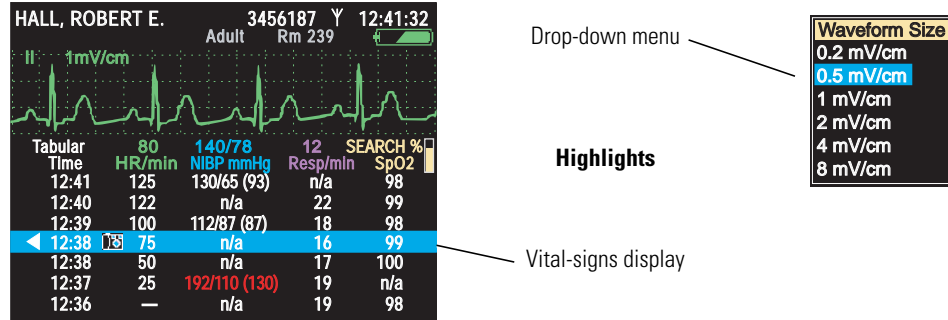



In a display screen (see “About display formats” on page 19), pressing  causes the monitor to replace the current screen with another screen related to the current context. For example, if **SpO2** is highlighted in the Two waveforms display and you press ...

Figure 28. Using the action button ()



...the monitor presents the SpO₂ **control menu** (Figure 29).

About green highlights

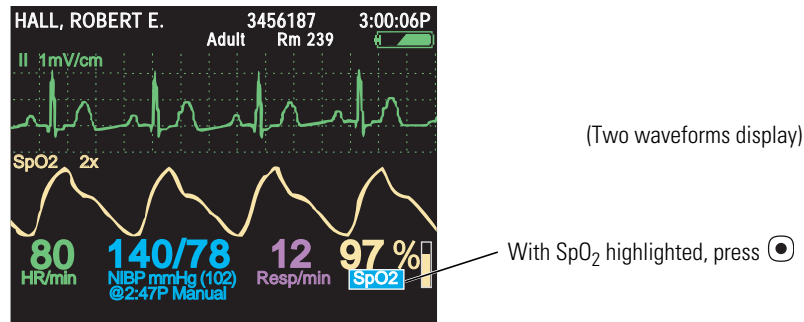
Green highlights identify the current values of parameters within a given context. For example, in the control menu shown in Figure 29, the current settings of the SpO₂ parameters are highlighted in green.

Menus

Using control menus

Figure 29. SpO₂ control menu (example)

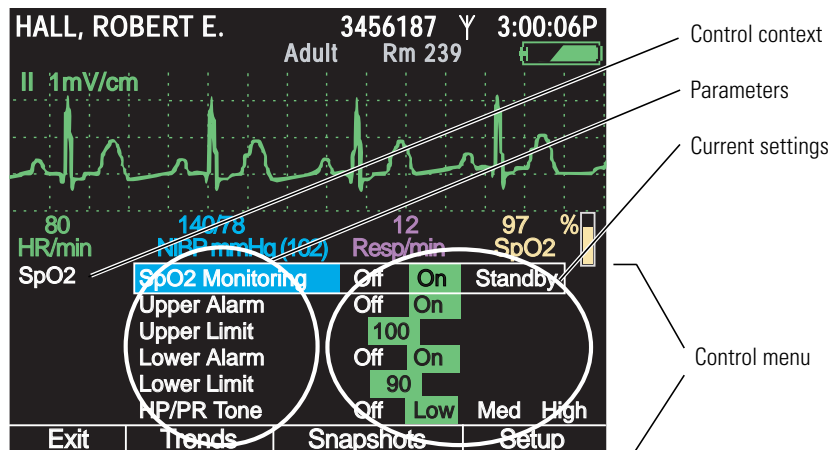

A control menu includes a topic name for the current context (for example, **SpO₂**); a column of parameters with one highlighted (for example, **SpO₂ Monitoring**); and a column of options, with one item in each set of options highlighted (for example, **On, On, 100, On, 90, Low**).

- The blue highlight indicates the parameter currently enabled for modification.
- The green highlights indicate the current settings for all parameters in the menu.

At the bottom of the screen for all control menus are links to **Exit**, **Trends**, **Snapshots**, and **Setup**.

Exit Return to the vital-signs display.

Trends View a tabular history.

Snapshots View a series of 21-second waveform snapshots of the current patient's vital signs.

Setup Access the setup menu. (See ["To access the setup menus"](#) on page 37.)

Example: Using a control menu

Using the example (Figure 29), you would do the following to raise the SpO₂ lower alarm limit to 95 (Step 1) and shut off the HR/PR tone (Step 2):

1. With **SpO₂ Monitoring** highlighted, scroll (using ▼) to highlight **Lower Limit**, and press ► as many times as needed to raise this alarm limit to **95**.

Note If you decrease an upper alarm limit to a value almost as low as the lower limit, the lower limit decreases so that it is always lower than the upper limit.
If you increase a lower alarm limit to a value almost as high as the upper limit, the upper limit increases so that it is always higher than the lower limit.

2. Scroll (using ▼) to **HR/PR Tone**, and press either ◀ or ▶ as many times as needed to highlight **Off**.

Note When you change a setting (for example, by turning off an alarm limit or by increasing or decreasing an alarm limit), the change takes effect immediately.

3. Press ⏪ or ⏩ to exit the control screen and return to the vital-signs display.

Note When you exit a control menu, *the values displayed at the time you exit are the values in effect for the monitor*. If you change a parameter setting and then decide before exiting the control menu to keep the previous setting values, you must return the parameters to the original values before you exit the control menu.

About the HR/PR control menu

Parameter	Options	Parameter	Options
Upper Alarm	Off On	Lower Alarm	Off On
Upper Limits		Lower Limits	
Adult	27 - 300 beats/minute	Adult	25 - 298 beats/minute
Pediatric	27 - 300 beats/minute	Pediatric	25 - 298 beats/minute
Neonate	27 - 300 beats/minute	Neonate	25 - 298 beats/minute
HR/PR Tone	Off Low Med High	Selected Source	ECG SpO ₂

About the SpO₂ control menu

Parameter	Options	Parameter	Options
SpO ₂ Monitoring	Off On Standby	HR/PR Tone	Off Low Med High
Upper Alarm	Off On	Lower Alarm	Off On
Upper Limit		Lower Limit	
Adult	52% - 100%	Adult	50% - 98%
Pediatric	52% - 100%	Pediatric	50% - 98%
Neonate	52% - 100%	Neonate	50% - 98%

About the NIBP control menu

The NIBP control has submenus Manometer, Systolic, Diastolic, and Mean. Press ◀ or ▶ to select one.

Figure 30. NIBP control menu

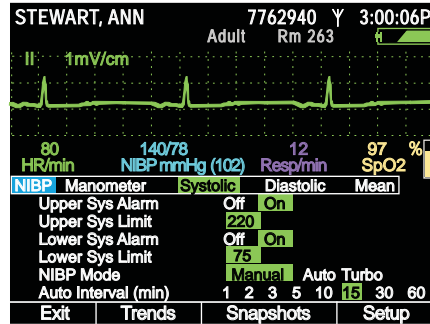

Parameter	Options
Systolic	
Upper Sys Alarm	Off On
Upper Sys Limit	
Adult	32 - 260 mmHg
Pediatric	32 - 160 mmHg
Neonate	27 - 120 mmHg
NIBP Mode	Auto Manual Turbo
Diastolic	
Upper Dia Alarm	Off On
Upper Dia Limit	
Adult	22 - 235 mmHg
Pediatric	17 - 130 mmHg
Neonate	12 - 105 mmHg
NIBP Mode	Auto Manual Turbo
MAP	
Upper MAP Alarm	Off On
Upper MAP Limit	
Adult	22 - 255 mmHg
Pediatric	17 - 140 mmHg
Neonate	12 - 110 mmHg
NIBP Mode	Manual Auto Turbo

Parameter	Options
Systolic	
Lower Sys Alarm	Off On
Lower Sys Limit	
Adult	30 - 258 mmHg
Pediatric	30 - 158 mmHg
Neonate	25 - 118 mmHg
Auto Interval (min)	1 2 3 5 10 15 30 60
Diastolic	
Lower Dia Alarm	Off On
Lower Dia Limit	
Adult	20 - 233 mmHg
Pediatric	15 - 128 mmHg
Neonate	10 - 103 mmHg
Auto Interval (min)	1 2 3 5 10 15 30 60
MAP	
Lower MAP Alarm	Off On
Lower MAP Limit	
Adult	20 - 253 mmHg
Pediatric	15 - 138 mmHg
Neonate	10 - 108 mmHg
Auto Interval (min)	1 2 3 5 10 15 30 60

About the Resp control menu

Parameter	Options	Parameter	Options
Resp Monitoring	Off On	Lower Alarm	Off On
Upper Alarm	Off On	Lower Limit	
Upper Limit		Adult	2 - 148
Adult	4 - 150	Pediatric	2 - 148
Pediatric	4 - 150	Neonate	3 - 148
Neonate	5 - 150	Resp Lead	Ld1 (RA-LA) Ld2 (RA-LL)

Using setup menus

Use the **Setup** menus—**Alarms**, **ECG**, **NIBP**, **SpO₂**, and **Timings**—to define settings for monitor behavior.

Setting	Options
Alarms	
Suspend Audible Alarms	Off, On (with a time value)
Alarm Tone	Low, Med, High
ECG	
Resp Monitoring	Off, On
ECG Bandwidth	Monitor, Extended
Power Source Filter	60 Hz, 50 Hz, Off
Pacer Indicator	Off, On
NIBP	
NIBP Format	SD, SD(m), sd(M)
NIBP Units	mmHg, kPa
Smartcuf	Off, On
SpO₂ (Masimo only)	
Sensitivity	Normal, Maximum, APOD™
FastSAT™	Off, On
Averaging Time	2, 4, 8, 10, 12, 14, 16
Timings	
Back Light Time Out (Min)	2, 5, 10, 15, 30, On, Off
Display Time Out (Min)	2, 5, 10, 15, 30, On
Demo Mode	Disabled, Low, High

Use the **Setup -> Configuration** menu to change the monitor configuration without using the Configuration Utility.

Option	Note
	Configuration
Select (●) to save current settings.	Replace the power-up defaults with the current parameter settings.
Select (●) to use factory settings.	Replace the power-up defaults with the factory settings.
Select (●) to use file: [file name]	Replace the power-up defaults with the last downloaded configuration settings.

To access the setup menus

From any main display screen (such as Large Numerics, Dual Waveform...):





1. Highlight , **HR/PR**, **SpO2**, **NIBP**, **Resp**, or .
2. Press (●).
3. Highlight **Setup** (at the bottom of the screen) and press (●).

Figure 31. Setup menus

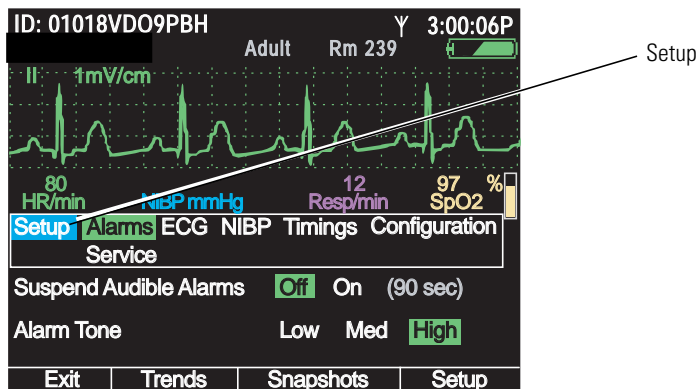

Note If you change parameter settings and then change the patient mode (from adult to pediatric, for example):

- All parameters are reset to the configuration default values for the new patient mode.
- All stored patient data is lost.

 **WARNING** The Setup menus are also used to access the Service menu. Do not enter the Service menu unless you are a qualified service person.

About monitor information screens

Both the start-up information screen and the monitoring information screen provide information about the monitor.

To view the start-up information screen

From the power-on screen (Figure 7 on page 13), highlight **Info**.

Figure 32. Start-Up Information

Welch Allyn Propaq 802LTRN Serial# F82C0DD5 V1.00.00	Welch Allyn Propaq 802LT0N Serial# AB72383-1 V1.00.00
Portland Westside Emergency Department PtdWstsdED10Jun05.mnt Ann Jones, MD 503-530-0101 x9999 Patient Mode Adult Snapshots none saved Wireless Communications Enabled	Portland Westside Emergency Department PtdWstsdED10Jun05.mnt Ann Jones, MD 503-530-0101 x9999 Patient Mode Adult Snapshots 14 of 20 saved Wireless Communications Disabled
Start New Patient Info Demo	Start New Patient Continue Patient Info Demo

The start-up information screen provides the following:

- Monitor type (LTRN=wireless, LT0N=standalone), serial #, and software version # (V X.XX.XX)
- Medical facility name and department
- Configuration file name
- Contact person's name and telephone number
- Current patient mode (Adult, Pediatric, Neonate)
- Number of data snapshots saved (0 - 20)
- Network communications status (Enabled, Disabled)

To exit the start-up information screen, do one of the following:

- Highlight **Continue Patient** or **Start New Patient** to start monitoring.
- Highlight **Demo** to enter Demo mode.
- Press  to turn off the monitor.

To view the monitoring information screen



Highlight  (in the upper right corner of the vital-signs display) and press .

Figure 33. Monitoring information



The monitoring information screen provides the following information:

- Continuous numeric and waveform display of patient vital signs
- Medical facility name and unit
- Configuration file name
- Contact person's name and telephone number

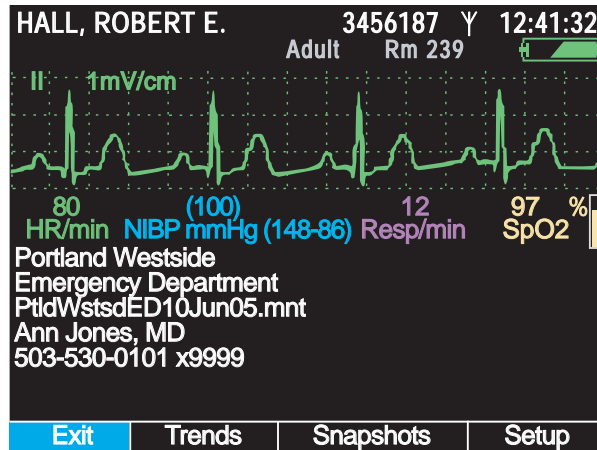
Note If a monitor configuration is saved after a configuration file is downloaded, the file name shown in the information screen is followed by an asterisk (*). This is true even if the saved configuration is identical to the downloaded configuration.

Portland Westside
Emergency Department
PtdWstsdED10Jun05.mnt*
Ann Jones, MD
503-530-0101 x9999

For more information about changing the monitor configuration, see [“Changing the default settings”](#) on page 69.

To exit the monitoring information screen, do one of the following:

- To return to the primary display, press , or highlight **Exit** and press .
- To see a tabular display of vital signs, highlight **Trends** and press .
- To view saved snapshots of vital signs, highlight **Snapshots** and press .
- To view the Setup menu, highlight **Setup** and press .
- To turn off the monitor, press .

Using demo mode

In Demo mode, the monitor displays simulated patient data for all vital signs. You can use Demo mode to familiarize yourself with the following:

- Viewing vital-signs displays
- Modifying alarm limits and other settings
- Cycling through display formats
- Responding to alarm conditions

To start Demo mode, all of the following must be true:

- The power-on screen is displayed.
- The monitor is not in NIBP Auto mode.
- Patient data was deleted when the monitor was last shut down; that is, the monitor contains no stored patient data.
- The SpO₂ and ECG cables are not connected to the monitor.

To enter demo mode low

1. Verify that the SpO₂ and ECG cables are not connected to the monitor.
2. Cycle the monitor off (deleting any saved data) and then on again.
3. When the main screen appears, highlight **Demo** and press .

Note If you enter Demo mode with an SpO₂ or ECG cable connected, the monitor enters Demo mode for only a second or two before shutting down and powering up in monitor mode.

If you are in Demo mode and you connect an SpO₂ or ECG cable or select NIBP auto mode, the monitor shuts down and powers up to the start-up screen.

Figure 34. Power-on screen: Demo highlighted

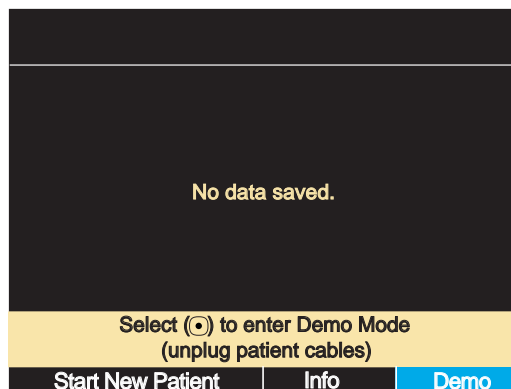

Demo mode is indicated by the message 'SIMULATION' in the upper left corner of the screen. If the monitor is connected to Acuity, 'SIMULATION' also appears on the Acuity display.

Figure 35. Demo mode: initial display

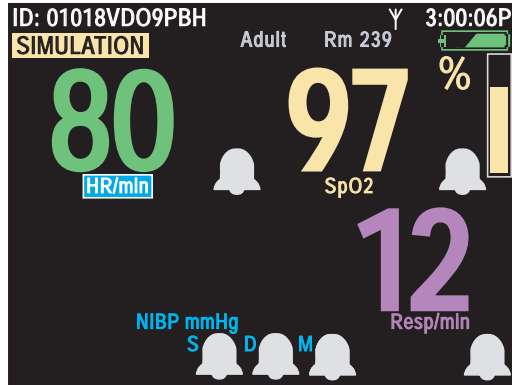

When you enter Demo mode, the monitor is in 'Demo mode low'. In this mode, the simulated vital signs of the patient are steady and do not cause any alarms at the default alarm limit settings. You can explore the monitor displays and menus, and you can change the same settings and values in Demo mode that you can change in normal mode.

In Demo mode low, if you adjust the alarm limits to put the simulated patient's vital signs out of limits, the monitor simulates an alarm condition. Another way to simulate an alarm condition is to switch the monitor to Demo mode high, which uses higher numeric values.

To switch to demo mode high

1. Access the **Setup** menu. (“To access the setup menus” on page 37.)
2. Press **▶** to highlight **Timings**.

Figure 36. Setup: timings

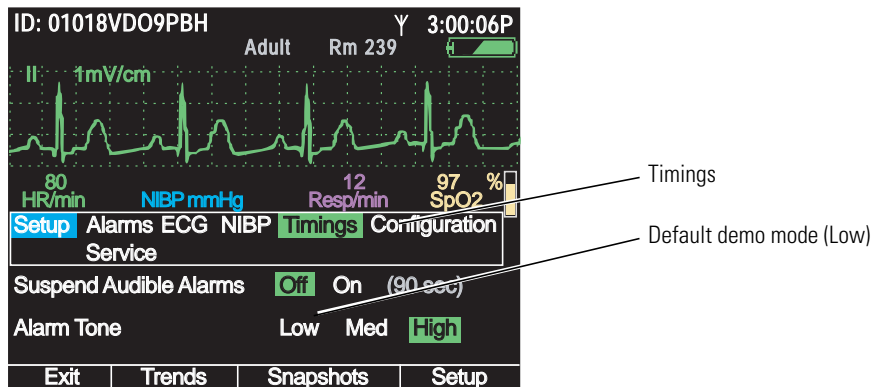

The Timings menu specifies the Demo mode—**Demo mode low**, which simulates normal vital signs, and **Demo mode high**, which simulates a higher heart rate (HR), higher respiration rate (Resp), and lower oxygen saturation (SpO₂).

- Press ▼ to highlight **Demo mode**, and press ◀ or ▶ to highlight **High**.

Figure 37. Setup: timings: demo mode high

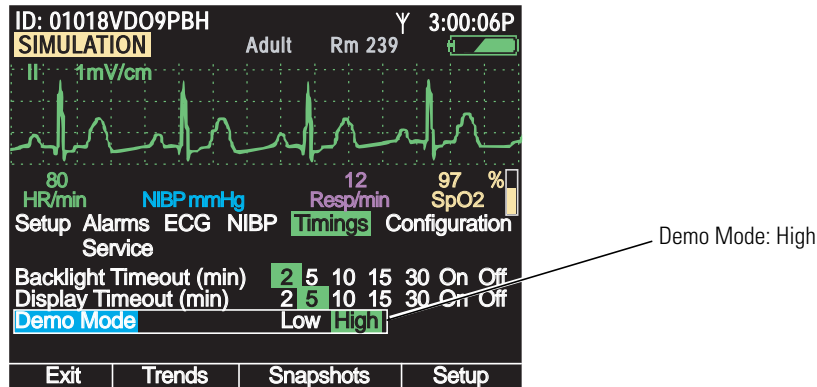

- Press ○ or  to return to the main display.

Figure 38. Demo mode high: initial display



The monitor generates an alarm within seconds of reading this new set of simulated vital signs. The red alarm indicator (Figure 39) illuminates and flashes, the numerics for all violating vital signs—HR, SpO₂, and Resp—turn red and flash, and the highlight moves to the most recent alarming numeric.

Figure 39. Demo mode high: simulated alarm condition

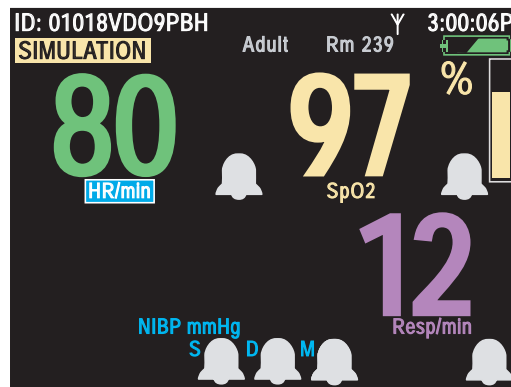
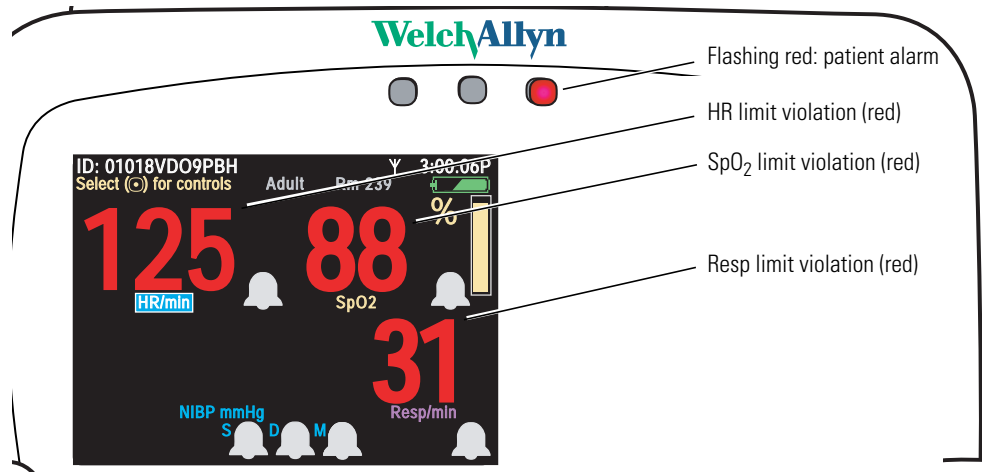
With the monitor simulating an alarm, you can practice responding to alarms. (See “Responding to an alarm” on page 85.)

To exit demo mode

Press . The Demo Mode Power Off screen appears.

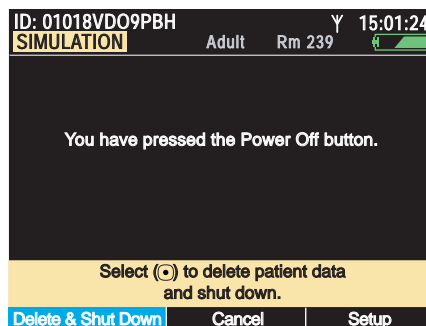
Figure 40. Demo mode power off

- To shut down the monitor, press . (No data can be saved from Demo mode.)
- To resume Demo mode, highlight **Cancel** and press .
- To access the Setup menu, highlight **Setup** and press .

Power saving

To maximize battery life, the monitor display shuts off when the following conditions are all true:

- No button press for a period of n seconds. (n is configurable.) See “Timing out the display and the back light” on page 20.
- No active alarms or alerts
- No Acuity Message window
- No Patient ID entry window

Turning off the monitor

To turn off the monitor

Press .

The Power-off screen appears:

Figure 41. Power-off screen

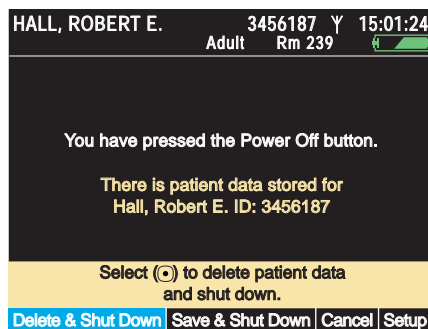

Highlight the desired action and press .

Note If you press  to power down before leaving the power-on screen (Figure 7 on page 13), the monitor shuts down without presenting the screen shown above.

Communicating with an Acuity Central Station

See “Monitoring in communication with Acuity” on page 73, and see *Acuity Directions for use*.

About error detection

The monitor can detect conditions that prevent it from operating properly. If this occurs, it displays an error message and an error number. Follow the directions displayed on the screen.

Transporting the monitor with the patient

An ambulatory patient can wear or carry the monitor using the **wearable strap** or the **patient carry strap** (optional accessories). Medical personnel can use the **transport stretcher carry strap** to keep the monitor with a patient during stretcher transport.



WARNING When the patient is wearing or carrying the monitor, carefully route any patient cabling to reduce the possibility of patient entanglement or strangulation. Use the supplied garment clips to secure the cable properly.

WARNING When positioning straps on the patient, make sure the straps do not entangle the patient's neck or cause choking.

WARNING Make sure the straps do not restrict the movement of the patient's limbs or create a hazard for the patient when the patient is walking or moving.

WARNING Never use a strap to carry or pick up both the monitor and the cradle. The straps are not intended to support, and cannot support, the combined weight of the monitor and the cradle.

To attach the wearable strap



WARNING Do not put the wearable strap on the patient while the patient is in bed. The intended use of the wearable strap is to keep the monitor—**without the cradle**—with the patient when the patient is ambulatory.

Figure 42. Wearable strap

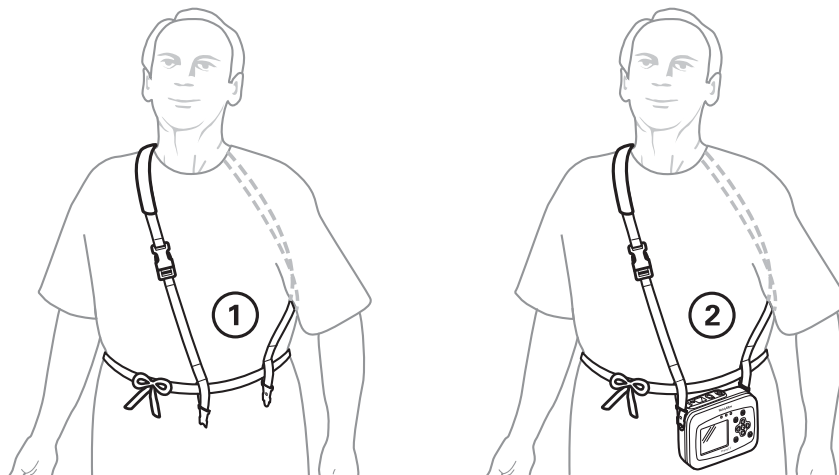

1. Place the wearable strap on the sitting or standing patient and adjust all components for a comfortable, secure fit (Figure 42 left).
2. Connect the wearable strap securely to the monitor strap mounts (Figure 42 right).
3. Carefully arrange the strap and the monitor on the patient to avoid bruising or other skin injuries.

To use the patient carry strap



WARNING Do not use the patient carry strap to lift or carry both the monitor and the cradle. The patient carry strap is not intended to support (and cannot support) the weight of both the monitor and the cradle. Attempting to carry both the monitor and the cradle with a patient carry strap could lead to patient injury and to damage to the monitor and the cradle.

1. Remove the monitor from the cradle.
2. Detach the monitor cables from any accessories.
3. Verify that all cables are disentangled from the bed and any bedside tables.
4. Connect the ends of the carry strap to the strap mounts on the monitor.

Note Be sure that each end of the carry strap snaps into place.

Figure 43. Patient carry strap

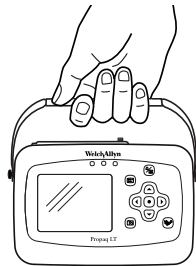

To use the transport stretcher carry strap

1. With the monitor facing away from the stretcher and the patient, attach one end of the strap to a monitor strap mount.
2. Run the monitor strap under the stretcher restraint straps, near the patient's waist.
3. Attach the other end of the strap to the other strap mount.

Figure 44. Monitor secured to the patient during stretcher transport



4. Before transporting the patient, verify that all monitor cables are clear.

3

Standalone monitoring

Overview

The monitor is available in standalone models (802LT0N and 802LT0S) and in wireless models (802LTAN, 802LTAS, 802LTRN and 802LTRS).

This chapter describes the operation of the standalone monitor and of the wireless monitor when it is not in communication with the Welch Allyn Flexnet[®] network and an Acuity[®] Central Station.

About the Model 802LT0N and 802LT0S (standalone) monitors

The model 802LT0N and 802LT0S monitors operate in standalone mode. They measure and display vital signs, store patient data, and locally indicate alarms and alert conditions.

- The configuration of the monitor is not affected by Acuity.
- The vital signs stored by the monitor are not sent to Acuity.
- Alarms and alerts generated by the monitor do not appear on Acuity.
- Alarms and alerts generated by Acuity do not appear on the monitor.
- Acuity does not update the monitor time and date settings.

About the Model 802LTAN, 802LTAS, 802LTRN and 802LTRS (wireless) monitors

See [“Monitoring in communication with Acuity”](#) on page 73.

Preparing for a new patient

To begin monitoring a new patient

1. If the monitor is on, press  to turn it off.



If prompted to save or delete existing data, highlight **Delete** and press . The monitor deletes any saved data and temporary settings, and then shuts down.
2. Press  to turn on the monitor.
 - If the monitor holds stored data from the previously monitored patient, it displays the “data saved” start-up screen:

Figure 45. Start-up with saved data

- If the data from the previously monitored patient was deleted on shut-down, the “no data saved” start-up screen appears:

Figure 46. Start-up with no saved data

3. Highlight **Start New Patient** and press \odot . The first configured data display appears.

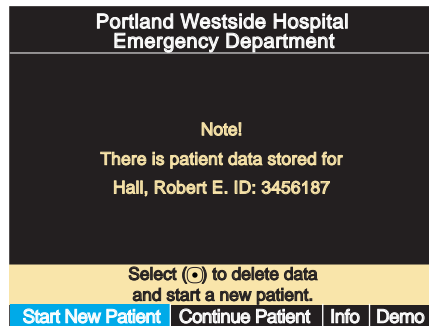
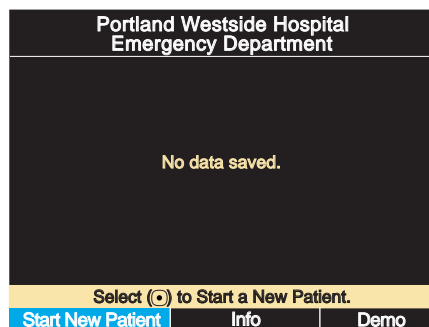
In place of a patient name, **ID:** is followed by a string that is generated by the monitor when you select ‘Start New Patient’. This AutoID string, unique to each new patient, identifies the patient until you supply appropriate patient identification data.

Note To bypass patient ID entry, press Ⓜ .

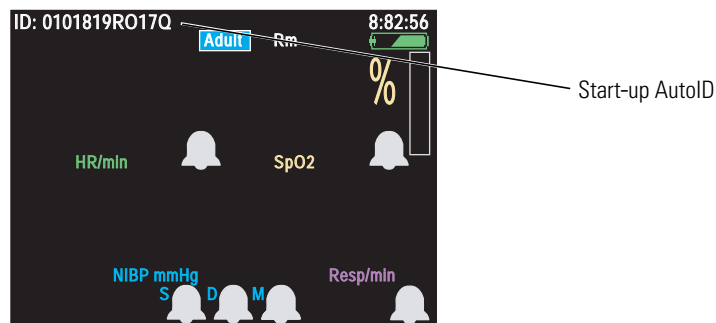
Figure 47. Data display with AutoID

4. In the primary data display, highlight **ID:** (upper left) and press \odot .
The Patient Information Entry screen appears:

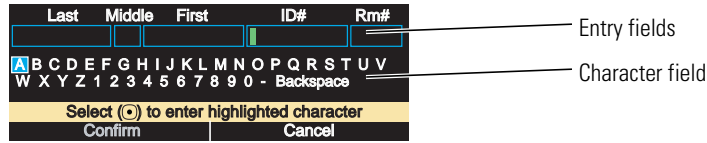
Figure 48. Patient information entry

5. Enter the ID and name of the new patient.
 - a. Press ◀ or ▶ to highlight (blue) a character in the character field (Figure 49).
 - b. Press (O) to copy it to the green-highlighted location in the entry fields (Figure 48).
 - c. Repeat from step a until all characters are entered into the field.
 - d. Press ▲ until the insertion point in the entry field changes from green to blue.
 - e. Press ◀ or ▶ to move the insertion point to another entry field.
 - f. Press ▼ to return to the character field.
 - g. Repeat from step a until all fields are complete.

Note To correct an error in an entry field: Place the cursor (step d and step e) to the right of the error location, highlight and enter **Backspace** in the character field to delete the erroneous character, and then enter the correct character.

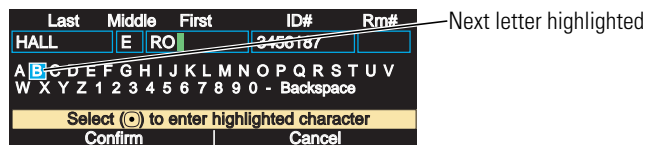
Figure 49. Patient information entry (continued)

6. Highlight **Confirm** and press (O).

Note Name alone is not sufficient to confirm a patient ID; thus, you can confirm the patient name only after you have entered the patient ID.

7. Verify that the patient mode (adult, pediatric, or neonate) is set correctly for this patient.

Neonatal Term birth through 28 days, or up to 44 gestational weeks.

Pediatric Between 29 days and 12 years.

Adult 13 years and older.

If the current patient mode setting is not correct:

- a. Highlight the current patient mode (**Adult**, **Pediatric**, or **Neonate**) and press (O).
- b. From the Patient Mode selection menu, highlight the appropriate patient mode and press (O).

Figure 50. Changing patient mode



c. A confirmation screen appears:

Figure 51. Confirming a change of patient mode

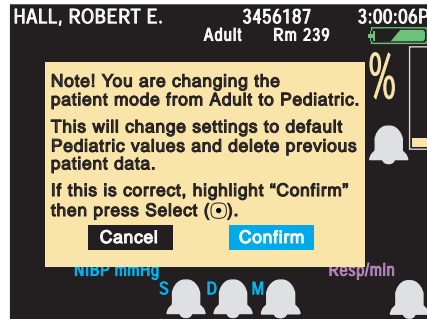

d. To confirm the change, highlight **Confirm** and press \odot .

Note When you change the patient mode and confirm the change:

- All vital-signs data for the patient is lost.
- All monitor settings revert to the defaults for the new patient mode.

8. Verify that the displayed time and date are correct.

- The monitor displays time in the 12-hour (AM/PM) or 24-hour format, and displays the date in the mm/dd/yy, dd.mm.yy, or yy/mm/dd format.
- The date does not appear on the primary display screens. It appears on the snapshot list and on the snapshot display.

a. Highlight the time display (in the upper right corner of the screen) and press \odot . The Time/Date screen appears.

Figure 52. Time/date screen: 24-hour format

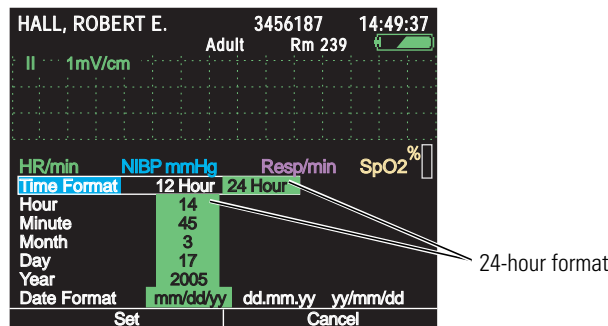

b. If the displayed time or date is not correct, press \blacktriangle or \blacktriangledown to move the highlight from one parameter to another, and press \blacktriangleleft or \blacktriangleright to change the value of the highlighted parameter. For example, to change the time display format from 24-hour to 12-hour, highlight **Time Format** and press either \blacktriangleleft or \blacktriangleright once.

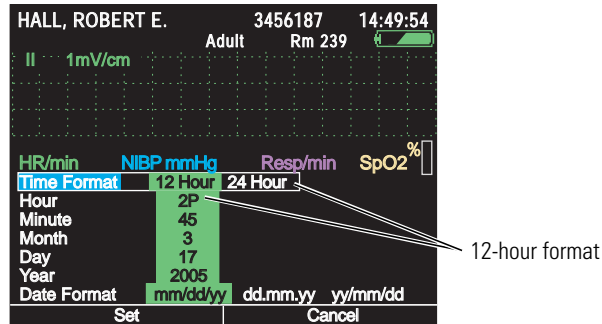
Figure 53. Time/date screen: 12-hour format

- c. When the time and date are correct and formatted appropriately, press to accept the changes and return to the vital-signs display.

Note If you change the time or date settings and then decide not to accept the changes, press to cancel the changes and return to the vital-signs display.

Continuing to monitor a patient on power-up

If patient data was saved when the monitor was last turned off (see [“To turn off the monitor”](#) on page 44), you can resume monitoring that patient when the monitor is turned on again. (When patient data is saved, the monitor settings are also saved.)

To resume monitoring the same patient:

1. Turn on the monitor. The “patient data stored” screen appears:

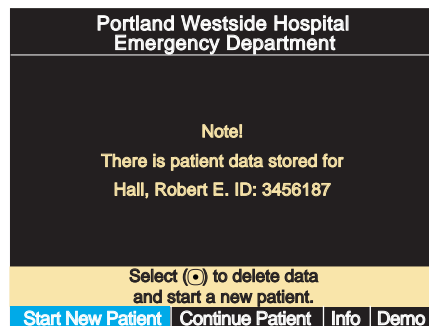
Figure 54. Start-up with saved data

2. Verify that the displayed name and ID match that of the current patient.
3. Highlight **Continue Patient** and press .

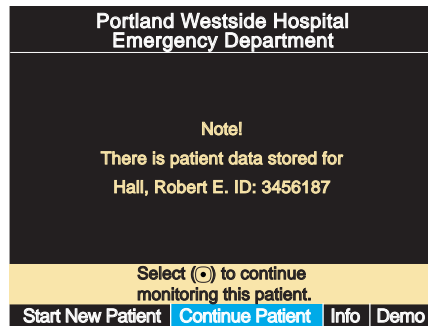
Figure 55. Start-up with saved data

Monitoring ECG and Resp

Overview

Note In this manual, **lead** refers to an ECG electrode or lead wire, and **Lead** refers to a waveform source.

You can monitor heart signs (ECG) and respiration rate (Resp) using either a 3-lead or a 5-lead ECG cable. Using a 3-lead cable, you can display one signal waveform for Lead I, II, or III. Using a 5-lead cable, you can display either one or two signal waveforms (I, II, III, V; and if enabled in the configuration, aV_R, aV_L, or aV_F). You can also display the SpO₂ or Resp waveform in place of an ECG waveform.



WARNING Always monitor and set alarms for SpO₂ when using impedance pneumography to monitor respiratory function.

WARNING When monitoring respiration via impedance pneumography, always select the ECG Lead with the most prominent QRS complex. The monitor rejects cardiovascular artifact, but this function depends upon accurate ECG R-wave detection.

WARNING Do not place the monitor near another respiration monitor. Resp measurement frequencies can cause mutual interference.

WARNING Do not perform impedance pneumography on paced patients. Pacemaker pulses can sometimes be falsely counted as breaths.

WARNING Always keep patient motion to a minimum. Motion artifact can cause incorrect readings of breath rate or heart rate.

WARNING If a disconnected lead is too close to other electrical devices, it can cause a false heart rate, a false respiration rate, or a failure to display a "Lead Fail" message.

WARNING The monitor displays + + + for HR numerics between 301-350 beats per minute. For heart rates above 350 beats per minute, it might display incorrectly low heart readings, due to intermittent picking of R-waves.

WARNING The monitor does not provide internal arrhythmia analysis; therefore, arrhythmias can cause the monitor to display inaccurate heart rates.

WARNING Make sure the patient mode is correct. Incorrect patient mode can result in inaccurate heart rate readings and inappropriate alarm settings.



WARNING (1) During a surgical procedure, do not use small ECG electrodes. (2) Select ECG electrode attachment points remote from the surgical site and remote from the electrosurgical return electrode. (3) Use electrosurgical return electrodes with the largest practical contact area. (4) Assure proper application of the electrosurgical return electrode to the patient.

High-intensity radio-frequency (RF) energy from external sources, such as an improperly connected electrosurgical unit, can induce heat into electrodes and cables, which can cause burns on the patient and can lead to measurement errors.

WARNING Always use the provided garment clips to route ECG cables away from the patient's head.

WARNING Use only accessories approved by Welch Allyn. The use of any other accessories can result in inaccurate patient data, can damage the equipment, and can void your product warranty. Refer to the accessory list or www.welchallyn.com.

WARNING Always use accessories according to the standards of your facility and according to the manufacturer's directions.

WARNING Never use ECG cables with loose or faulty detachable lead wires. These can cause erratic behavior of the ECG and respiration waveforms due to intermittent ECG lead wire connections.

WARNING Resp is derived from the same leads as the ECG channel, so the monitor determines which signals are cardiovascular artifact and which signals are a result of respiratory effort. If the breath rate is within five per cent of the heart rate or is a multiple or submultiple of the heart rate, the monitor might ignore breaths and trigger a respiration alarm.



Caution Never use an ECG cable longer than 10 feet (3 meters) including extensions. If you use an ECG extension cable with an ECG cable longer than 4 feet, the monitor acts as though no ECG cable is connected.

Caution To protect the monitor from damage during defibrillation or electrosurgery, for accurate ECG information, and for protection against noise and other interference, use only ECG electrodes and cables specified or supplied by Welch Allyn (these cables have the required current-limiting resistors). Follow recommended application procedures.

Note The monitor contains type CF fully isolated patient-connected circuitry, but it is not intended for direct application on a patient's heart.

Severe artifact and interference (such as defibrillation interference) can cause the waveform to move off of the display for a few seconds before it is restored.

Impedance pneumography (Resp) is not recommended for use with high-frequency ventilation.

The monitor counts as breaths any respiratory efforts larger than twice the background cardiovascular artifact.

Note Use only silver/silver chloride electrodes. Other electrodes, such as stainless steel electrodes, squeeze-bulb electrodes, or electrodes with dissimilar metals, are subject to large offset potentials due to polarization. Other electrodes can also have slower recovery time after the application of defibrillator pulses.

Monitoring ECG

1. Inspect the ECG cable. Replace it if it shows any signs of wear, breakage, or fraying.
2. Plug the cable into the monitor.
3. Select electrode sites on the patient, choosing flat areas and avoiding fatty or bony areas and major muscles.

Figure 56. ECG leads - actual placement

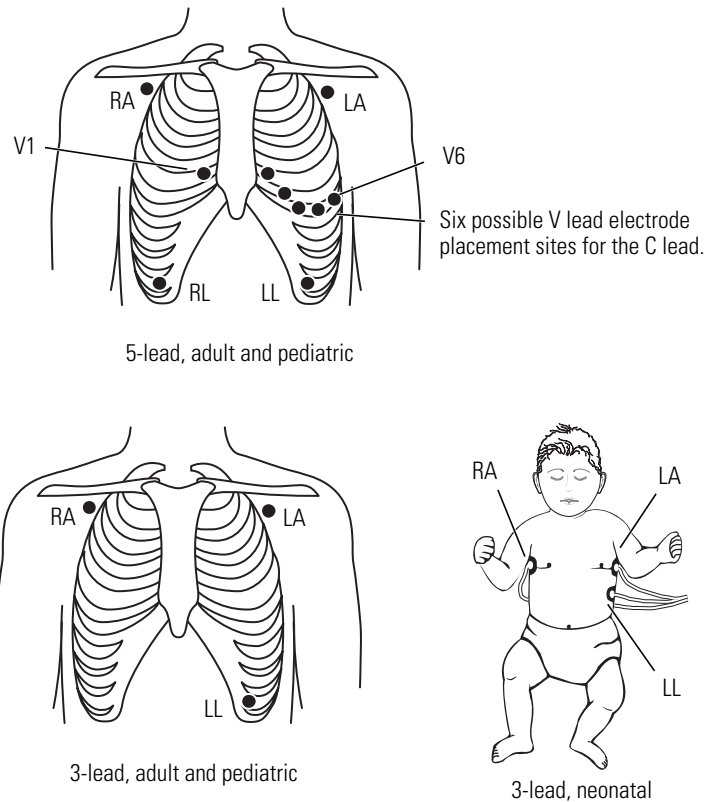

4. Shave or clip the hair from the electrode sites.
5. Thoroughly clean the skin, using soap and water, isopropyl alcohol, or skin preparation pads, and lightly rub it dry.



Caution To protect the patient from allergic reactions to electrodes, refer to the electrode manufacturer's directions for use.

6. If you are using gelled electrodes, verify that the electrode expiration date has not passed and that the gel is intact and not dried out.

If you are not using gelled electrodes, apply a mound of gel (1/4-inch to 1/2-inch, or 0.6-cm to 1.3-cm) to each electrode contact area.

7. Attach lead wires to the electrodes before applying them to the patient.
8. Apply the electrodes to the patient in the proper locations (Figure 56).

Note At least three appropriate electrode connections are required for ECG/Resp monitoring.

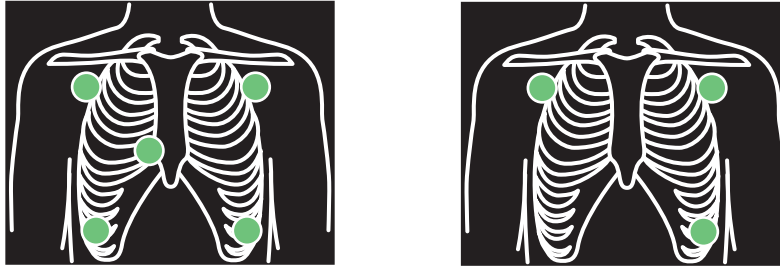
Figure 57. ECG leads - placement displays, 5-lead and 3-lead

The locations of the circles displayed on the monitor (Figure 57) for each lead are fixed, and do not indicate the exact placement of the electrodes on the patient.

If the monitor detects that some lead wires are not connected, it displays an “ECG Fault” equipment alert and a chest diagram indicating the location of the disconnected lead or leads. If the disconnected lead(s) invalidate the Lead used for HR determination, then the monitor reassigns, if possible, the Lead used for HR. If the reassignment succeeds, the monitor then displays another equipment alert with the message “ECG Lead changed”.

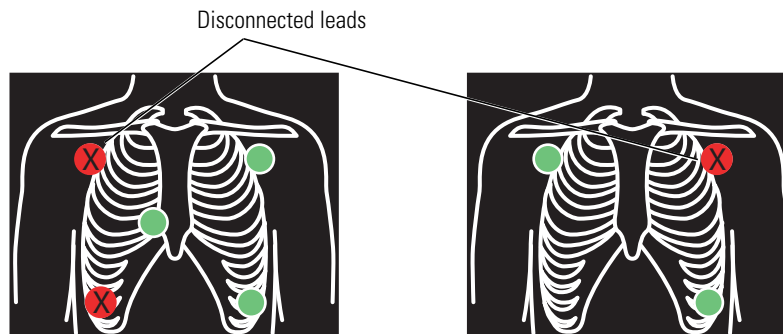
Figure 58. ECG leads - disconnected leads

9. When all leads are properly connected, confirm that the monitor displays the ECG waveform, heart rate, and other patient data.

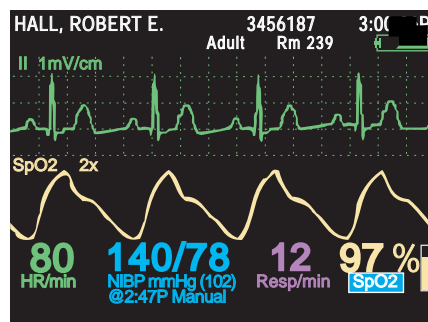
Figure 59. All vital signs displayed**To change the waveform selection**

1. Highlight the current waveform source selection (Lead II, for example) and press .

Figure 60. Waveform source: II



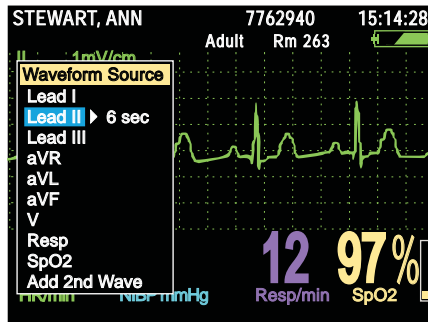

2. Highlight your waveform source choice and press  or .

Figure 61. Waveform source: Resp



Note If you scroll to the bottom selection of the Waveform Source menu—either **Add 2nd Wave** or **Remove 2nd wave**—the selection takes effect immediately and the monitor returns to the primary data display.

Note In the Waveform Source menu, either the source Lead or the waveform period can be highlighted. If the waveform period is highlighted, a second trace of the same source will be cascaded to double the period obtained from a single trace.

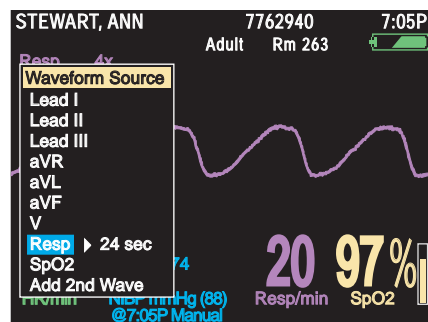
To change the waveform size

1. Highlight the current waveform scale (**1mV/cm**, for example) and press .

Figure 62. Waveform size popup menu

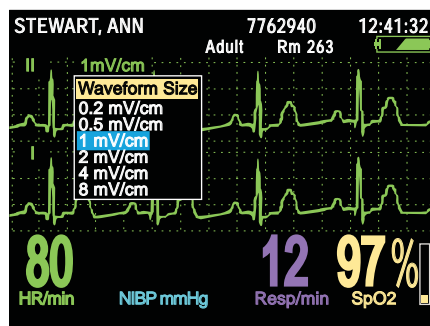

2. Highlight the desired scaling factor and press . (Waveform size does not affect QRS-detector sensitivity.)

About pacemakers and ECG monitoring

If the patient being monitored has a pacemaker, the monitor detects and can indicate the occurrence of pacemaker signals. If the Pacer Indicator setting is ON, the monitor displays and prints vertical dashed lines to indicate detected pacemaker signals. If Pacer Indicator is OFF, the monitor continues to detect the pacemaker signals but does not display or print the pacer markers.



WARNING Signals differ between pacemakers. The Association for Advancement of Medical Instrumentation (AAMI) cautions that “in some devices, rate meters may continue to count the pacemaker rate during occurrences of cardiac arrest or some arrhythmias. Do not rely entirely upon rate meter alarms. All pacemaker patients should be kept under close or constant observation.”

WARNING Use of respiration monitoring by impedance pneumography can affect the operation of some pacemakers. If pacemaker operation is affected, turn off respiration pneumography. (See [Figure 63](#) on page 57.)

WARNING Always use fresh ECG electrodes and make sure the ECG cable lead wires make good connections. The presence of pacer-like noise can cause the displayed heart rate to be erratic even though the ECG trace might look undistorted with the pacer indicator off.

To enable or disable the display of pacer indicators

1. Access the **Setup** menu. (See [“To access the setup menus”](#) on page 37.)
2. Highlight **ECG**.

Figure 63. Turning the pacer indicator off in the ECG setup menu

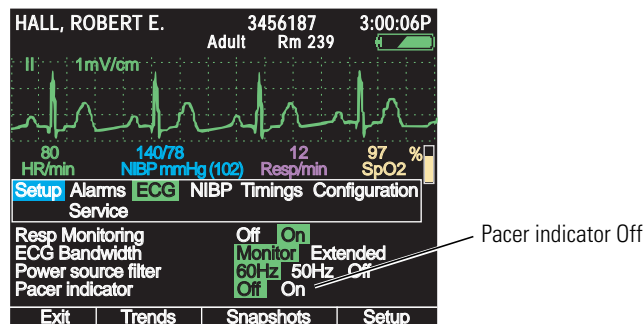

3. Highlight **Pacer indicator** and press **◀** or **▶** to highlight **Off** or **On**.
4. To exit the Setup menu, press **⊙** or **⏏**, or highlight **Exit** and press **⊙**.

Note If the pacemaker signal is strong enough, the monitor displays it as a waveform spike. This is true with Pacer indicator ON or OFF.

In accordance with the Pacer Pulse Rejection specification ([“Pacer pulse rejection”](#) on page 145.), pacemaker pulses are not counted as heartbeats whether Pacer Indicator is On or Off.

Noise on the ECG signal might be detected as pacer signals, causing the pacer indicator to appear on the display. If you do not need to indicate pacemaker signals, turn off the pacemaker indicator for a better ECG waveform display.

Improving the waveform display

If the power source filter is off, noise from the power source can cause an unclear or noisy waveform.

To change the power source filter to reduce noise

1. Access the **Setup** menu. (See “To access the setup menus” on page 37.)
2. Highlight **ECG**.

Verify that the setting for **Power source filter** is correct for the power source in your facility. If you do not know what this setting should be, consult a qualified service person.

3. Highlight **Power source filter** and press ◀ or ▶ as needed to select **60 Hz**, **50 Hz**, or **Off**.

Figure 64. Turning on the 60-Hz power source filter in the ECG setup menu

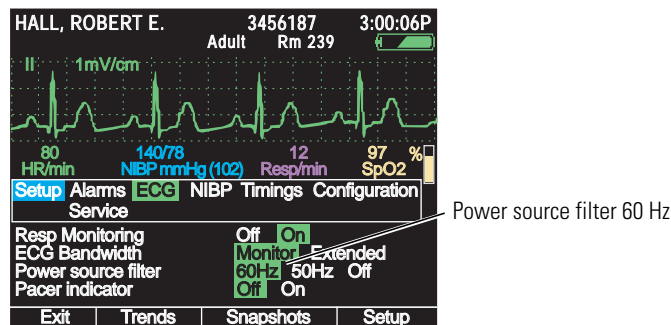

4. Exit the Setup menu by pressing or .

Monitoring respiration

Resp is based on impedance pneumography, where respirations are sensed from the ECG electrodes.

Note All ECG cables listed for the Propaq LT monitor in the accessory list or at www.welchallyn.com permit respiration monitoring and electrosurgical interference suppression.

Note To measure Resp with Lead II selected, the LL lead must be attached to the patient.

Resp is part of ECG monitoring. The Resp numeric is displayed (in purple) in the lower right corner. To view the Resp waveform:

Change the waveform source to **Resp**. (See “To change the waveform selection” on page 55.)

WARNING Use of respiration monitoring by impedance pneumography can affect the operation of some pacemakers. If pacemaker operation is affected, turn off respiration pneumography. (See Figure 63 on page 57.)

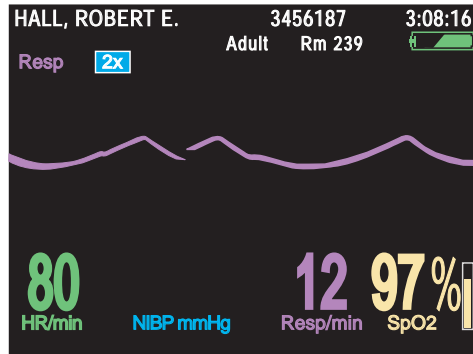
Figure 65. Resp waveform, default size (2x)

For more detail, change the waveform size to **8x**. (See “To change the waveform size” on page 56.)

Note Waveform size does not affect breath-detector sensitivity.

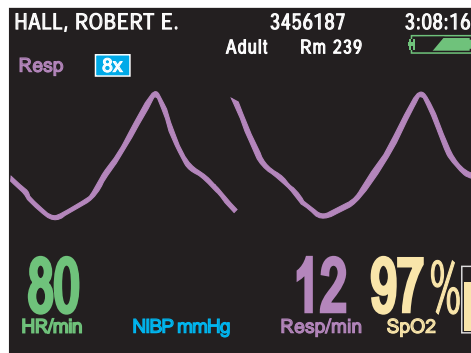
Figure 66. Resp waveform enlarged for detail (8x)

Monitoring SpO₂

The monitor can be purchased with the Nellcor or the Masimo SpO₂ option. Most of this chapter pertains to either configuration. Monitors with the Masimo technology, however, can provide additional SpO₂ data. (“About the Masimo SpO₂ display” on page 64.)



WARNING Accurate measurements of oxygen saturation, when derived from pulse oximetry, depend to a great extent on patient condition and proper sensor placement. Patient conditions such as shivering and smoke inhalation can result in erroneous readings. If you believe a measurement might be inaccurate, verify it using another clinically accepted measurement method, such as arterial blood gas measurements using a co-oximeter.

WARNING Use only SpO₂ accessories listed in the accessory list or at www.welchallyn.com. Inspect sensors and cables, and discard any that are damaged. Do not use a sensor with exposed optical components.

WARNING Use of Masimo LNOP sensors/cables will not provide protection in accordance with IEC defibrillation standards when used with this device.

WARNING If you need to increase the length of the sensor cable, use only one extension. Use of multiple extensions can adversely affect performance. Do not attach any cable that is intended for computer use to the SpO₂ connector at the monitor.

WARNING Tissue damage and erroneous measurements can be caused by incorrect application or use of a sensor. (Examples of bad practices: wrapping the sensor too tightly, applying supplemental tape, failing to periodically inspect the sensor site, leaving a sensor on too long in one place.) Refer to the manufacturer’s directions for specific instructions on application and use, and for description, warnings, cautions, and specifications.

WARNING Do not modify the sensor.

WARNING Do not wet the sensor or immerse it in fluid. Do not attempt to sterilize a sensor.

WARNING Sensors exposed to ambient light while not applied to a patient can exhibit seminormal saturation readings. Be sure the sensor is securely placed on the patient and check its application often to ensure accurate readings.

WARNING Inaccurate measurements might be caused by venous pulsations.

WARNING The pulse oximeter can be used during defibrillation, but the readings might be inaccurate for a short time.

WARNING Do not use the pulse oximeter as an apnea monitor.

WARNING During SpO₂ monitoring, a very sudden and substantial change in pulse rate can result in erroneous pulse rate readings. Always validate the patient data and patient condition before effecting an intervention or a change in patient care.



WARNING Interfering substances: Carboxyhemoglobin can erroneously increase readings; the level of increase is approximately equal to the amount of carboxyhemoglobin present. Methemoglobin and other dysfunctional hemoglobins can also cause erroneous readings. Further assessment beyond pulse oximetry is recommended. Intravascular dyes, or any substances containing dyes, that change usual arterial pigmentation can cause erroneous readings. Darkly pigmented skin can adversely affect SpO₂ readings.

WARNING For a premature infant, high oxygen levels might predispose the infant to develop retinopathy. Therefore, the upper alarm limit for oxygen saturation must be carefully selected in accord with accepted clinical standards and considering the accuracy range of the monitor.



Caution If liquid gets into the SpO₂ connector cavity, discontinue SpO₂ monitoring until the liquid is removed and the cavity is dry.

1. Inspect the SpO₂ cable. Replace it if it shows any signs of wear, breakage, or fraying.
2. Plug the cable into the sensor and the monitor.

Each SpO₂ sensor is intended for application to a specific site and site size on the patient. To obtain optimal performance, use the right sensor and apply it as instructed by the sensor manufacturer.

3. Clean the application site. Remove anything, such as nail polish, that could interfere with the operation of the sensor.
4. Attach the SpO₂ sensor to the patient according to the manufacturer's directions for use, observing all warnings and cautions.
5. Confirm that the monitor displays SpO₂ data within a few seconds of being connected to the patient.

Note In some newer monitors, the pitch of the heart tone rises and falls as oxygen saturation increases and decreases. In other monitors, the pitch of the heart tone does not change.

- If ambient light is too bright, shield the sensor site with opaque material. Failure to do so can result in inaccurate measurements. Light sources that can affect performance include the following:
 - surgical lights (especially those with a xenon light source)
 - bilirubin lamps
 - fluorescent lights
 - infrared heating lamps
 - direct sunlight.
- To help reduce unnecessary SpO₂ alarms when NIBP and SpO₂ are monitored simultaneously, place the NIBP cuff and the SpO₂ sensor on different limbs.
- Do not attach the SpO₂ sensor on the same limb as an arterial catheter or intravascular line.
- The pulse signal can disappear if any of the following conditions exists:
 - the sensor is too tight
 - ambient light is too bright
 - an NIBP cuff is inflated on the same limb as the sensor
 - arterial occlusion occurs near the sensor

- the patient is in cardiac arrest or shock
 - the patient has hypotension, severe vasoconstriction, severe anemia, or hypothermia
- If poor perfusion affects performance for an adult, consider using the adult nasal sensor.
 - If a sensor is connected and the sensor light does not come on within 3 seconds:
 - Verify that SpO₂ is turned on (Figure 67 on page 62)
 - Replace the sensor
 - If excessive or prolonged patient movement interferes with measurements, consider the following possible solutions:
 - be sure the sensor is secure and properly applied
 - use a new sensor with fresh adhesive backing
 - select a different type of sensor
 - move the sensor to a less active site
6. Periodically verify that the sensor remains properly positioned on the patient.

About SpO₂ spot check

Note The Spot Check feature is available only if it is enabled in the monitor configuration. Refer to “Using the Configuration Utility to configure the monitor” on page 116.

When SpO₂ is turned on, the monitor generates an alarm condition whenever SpO₂ readings are interrupted, such as when the sensor is disconnected from the patient after the monitor begins taking SpO₂ readings.

Using the SpO₂ Spot Check feature, however, you can take any number of spot SpO₂ readings at random intervals, attaching and detaching the sensor repeatedly without generating alarms.

To prepare to take a spot check reading

1. Highlight **SpO2** and press **⊙**.
2. Highlight **SpO2 Monitoring**, press **◀** to highlight **Off**, and press **⊙** to return to the main screen.

Figure 67. Turning off SpO₂ monitoring

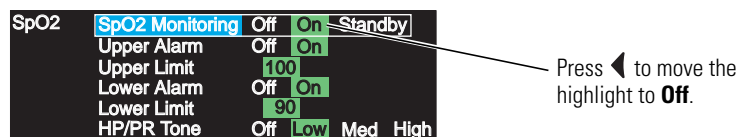

'SpO₂' has changed to 'SpO₂ @ (time)'. Spot checks are now enabled.

Figure 68. SpO₂ monitoring turned off

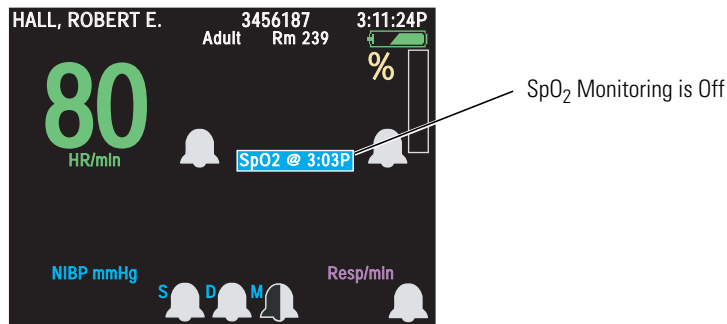

To take an SpO₂ spot check reading

1. Enable spot checks. (See “To prepare to take a spot check reading” on page 62.)
2. Attach the sensor to the monitor and the patient.
3. Highlight **SpO₂ @ XX:XX** and press **⊙**. The SpO₂ drop-down menu appears.

Note The SpO₂ drop-down menu can be accessed only when SpO₂ is set to **Off**.

Figure 69. SpO₂ drop-down menu

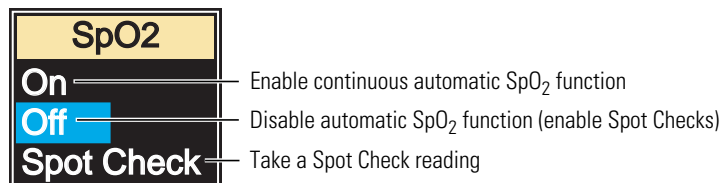

4. Press **▼** to highlight **Spot Check**.
 - The drop-down menu disappears. **SEARCH** appears above SpO₂ Spot Check (with pulse rate if SpO₂ is the source of pulse rate).

Figure 70. SpO₂ spot check: waiting for an SpO₂ signal

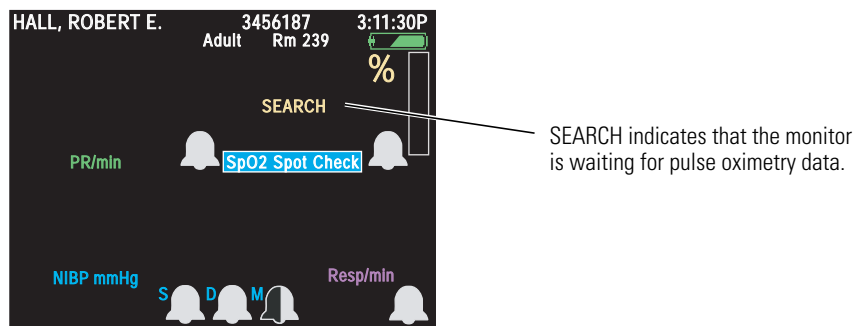

- After a few seconds, the SpO₂ heart-beat indicator starts showing heart beats.
- After about 30 seconds, **SEARCH** disappears and the pulse oximetry reading appears.

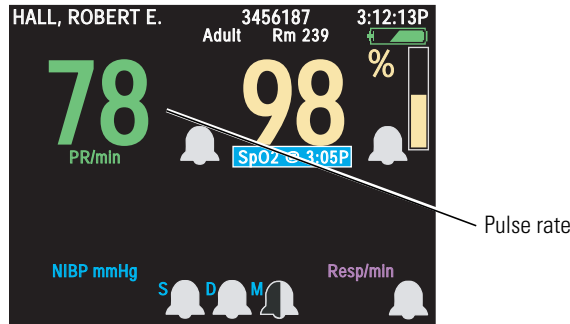
Figure 71. SpO₂ spot check: pulse rate reading

- The spot check ends, and SpO₂ monitoring is again turned off.
- The SpO₂ text on the display screen now includes the time of the most recent SpO₂ measurement. For example: **SpO2 @ 3:05P**.

Note Spot-check readings are included in trend displays.

5. Detach the sensor from the patient.
6. To take another spot check later, repeat from [step 2](#) (above).

To return to continuous SpO₂ measurements

1. Highlight **SpO2 @ XX:XX** and press **⊙**.
2. Press **▲** to turn automatic SpO₂ **On**. The pop-up menu disappears.

To adjust the SpO₂ and ECG pulse tone volume

1. Highlight **SpO2** and press **⊙**.
2. Highlight **HR/PR Tone**.
3. Highlight the desired volume level (**Off**, **Low**, **Med**, or **High**) and press **⊙**.

About the Masimo SpO₂ display

The Masimo SpO₂ option provides the following additional features and indicators.

Note The monitor (models 802LTAS, 802LTRS and 802LT0S) must be configured specifically to display the Masimo parameters.

Signal IQ (SIQ)	(Signal Identification and Quality indicator) A horizontal line below the SpO ₂ waveform, with vertical spikes indicating the relative reliability of the oxygen saturation readings. (Higher spikes indicate greater reliability.)
Perfusion Index (PI)	An assessment, expressed as a percentage between 0.02 and 20, of the relative pulse strength at the monitoring site.
FastSAT™	The tracking of rapid changes in arterial oxygen saturation.
Sensitivity	Normal, APOD, and Maximum.

Normal	For typical monitoring.
APOD	For monitoring when the probe is likely to detach from the patient because of wet skin, motion, or other unusual circumstances.
Maximum	For monitoring patients with extremely low perfusion.
Averaging Time	The period (in seconds) over which multiple SpO ₂ measurements are taken and a result is derived.

Monitoring blood pressure (NIBP)



WARNING Always use a properly fitting cuff, placing it carefully on the patient according to the instructions presented below. Failure to fit and locate the cuff correctly can lead to inaccurate pressure readings.

WARNING During monitoring, periodically observe the patient's limb to make sure that the circulation is not impaired for a prolonged period. Prolonged impairment of circulation or improper cuff placement can cause bruising.

WARNING Do not use the monitor to simultaneously measure NIBP on one patient and monitor ECG on another patient.

WARNING If an NIBP measurement is suspect, repeat the measurement. If you are still uncertain about the reading, verify it using another method.

WARNING Do not take NIBP measurements during cardiopulmonary bypass.

WARNING When monitoring NIBP, match the monitor patient mode to the NIBP cuff. For neonates, set the monitor to **Neonatal Mode** unless the circumference of the limb is too large for the cuff. In that case, use the **Pediatric Mode**. Be aware, however, that the maximum cuff inflation limits are based on the patient mode, not the cuff; the maximum cuff inflation limits for Pediatric Mode are greater than for Neonate Mode. (See "NIBP" on page 148 for values.)



Caution Pulse-rate measurements generated through the blood pressure cuff or through SpO₂ are subject to artifact and might not be as accurate as heart-rate measurements generated through ECG or through manual palpation.

When the monitor is powered on, the default cuff inflation pressure is based on the patient mode. (See "Default inflation pressure" on page 148.) After an NIBP measurement occurs, the monitor adjusts the inflation pressure to optimize subsequent NIBP measurements.

Note Always cycle the monitor power before you begin to monitor another patient.

Normal physiological pressure variations affect NIBP measurements from reading to reading.

If the monitor is in Adult mode and a neonate cuff is connected to the monitor, the monitor generates an equipment alert.

If the battery charge is low and the monitor is not in the cradle, the battery icon indicates low battery and NIBP monitoring is disabled.

To monitor blood pressure

1. Select cuff size based on limb circumference. Use only hoses and cuffs listed in the accessory list or at www.welchallyn.com.
2. Squeeze all the air from the cuff before placing the cuff on the patient.
3. Place the cuff on the limb, as near heart level as possible.

Figure 72. Cuff placement

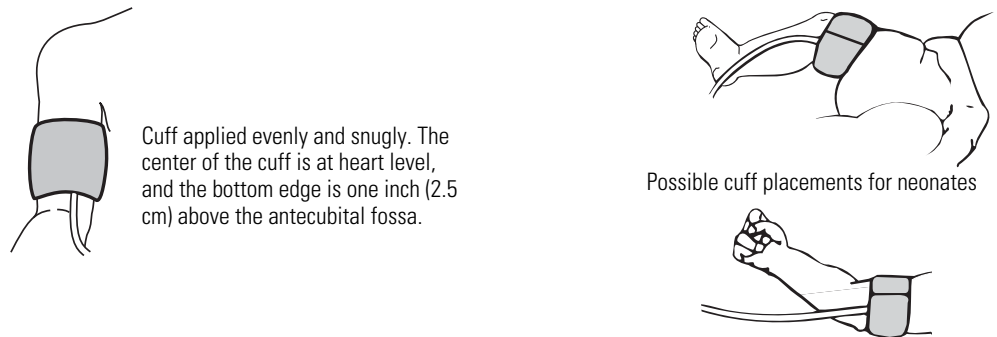

- The cuff must fit snugly without being uncomfortably tight.
 - The hose must be free of kinks and not pinched.
4. Align the point where the tubing connects to the cuff over the brachial or other appropriate artery.

Note If you are simultaneously monitoring blood pressure and SpO₂, you can reduce or eliminate unnecessary SpO₂ alarms by placing the cuff and the SpO₂ sensor on different limbs.

5. Screw the hose connector onto the NIBP air connector on the top of the monitor (see [Figure 4](#) on page 9).
6. Press  to start a reading.

Within a few seconds, the pump starts, the cuff begins to inflate, and the manometer screen appears.

Figure 73. NIBP: initial view

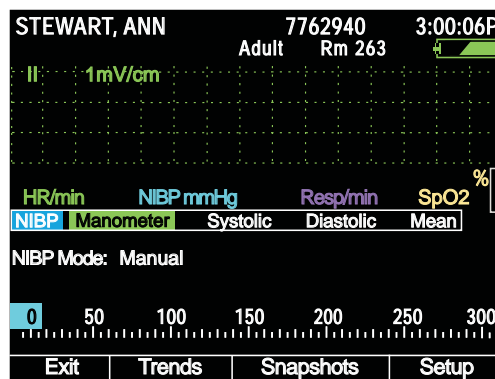

7. When the cuff is fully inflated, the manometer bar dynamically displays the pressure reading.

Figure 74. NIBP: reading in progress

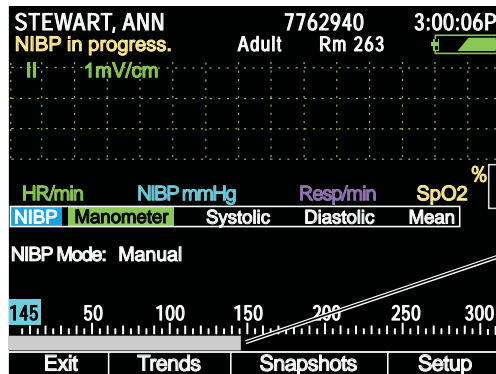

Manometer pressure indicator bar

When the cycle completes, control returns to the previous direct-access display. To view the final NIBP readings on the manometer scale, select **Manometer** from the **Setup NIBP** menu.

Figure 75. NIBP: reading complete

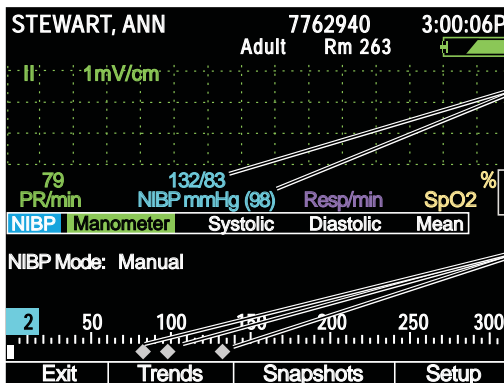

Systolic, diastolic, and MAP (numeric)

Systolic, diastolic, and MAP (graphical)

- If you need to stop the reading and vent the cuff at any time during the measurement, press .
- If the monitor cannot get a valid NIBP reading, it displays the message 'NIBP retry in progress' in the upper left corner of the screen. Then, depending on settings and patient mode, the monitor attempts one or two more measurements. If the retries fail to produce a valid reading, the monitor displays an NIBP error message.

Note For every inch the cuff is placed above the heart, add 1.9 mmHg (0.253 kPa) to the displayed NIBP reading. For every inch below the heart, subtract 1.9 mmHg (0.253 kPa).

8. If motion artifact such as shivering or coughing interferes with NIBP readings, do the following:
 - Position the patient's limb away from the body so that the applied cuff is not in contact with the patient's body or any other object (such as a bed rail). Keep the cuff as close to heart level as possible.
 - Verify that the Smartcuf filter is ON. (See "[Improving NIBP accuracy with Smartcuf](#)" on page 68.)
 - Verify that the ECG leads are properly connected to the patient, and monitor ECG during NIBP. (ECG monitoring is required for Smartcuf.)

Note The message **???/???/(???)** in an NIBP TREND display or printout indicates that the monitor could not complete an NIBP measurement during that period.

Note On-demand NIBP readings (manual or turbo) are delayed by 8 seconds if they are started while the monitor is in a power-saving mode such as display time-out.

Improving NIBP accuracy with Smartcuf

Many factors can adversely affect an NIBP measurement: cardiac arrhythmias, sudden changes in blood pressure, patient motion such as convulsions or shivering, sudden cuff movement, vibration, vehicle motion, or a weak pulse. The Smartcuf feature increases NIBP measurement accuracy in the presence of moderate motion artifact or diminished pulses.

Note Smartcuf can function only when ECG is being monitored.

To enable Smartcuf

1. Simultaneously monitor ECG and NIBP.
2. Access the **Setup** menu. (See [“To access the setup menus”](#) on page 37.)
3. Highlight **NIBP**, highlight **Smartcuf**, and enable the Smartcuf filter.

If Smartcuf is enabled and motion artifact is so severe that it still affects measurement accuracy, the measurement is marked with the symbol  on the display. During certain types of arrhythmias and other situations where a good ECG signal cannot be obtained, consider disabling Smartcuf, as follows:

To disable Smartcuf

1. Access the **Setup** menu.
2. Highlight **NIBP**, highlight **Smartcuf**, and disable the Smartcuf filter.

Taking automatic NIBP readings

In the Auto NIBP mode, for intervals shorter than 5 minutes, the monitor immediately begins taking NIBP readings at the specified interval. For intervals of 5 minutes or longer, the readings begin when the time of day is a multiple of the interval. (If the interval is 15 minutes, for example, then the readings begin at 00, 15, 30, or 45 minutes after the hour.)

To start automatic NIBP readings

1. Select and apply the appropriate NIBP cuff and hose. ([“Monitoring blood pressure \(NIBP\)”](#) on page 65.)
2. Highlight **NIBP** and press .
3. Highlight **NIBP Mode** and select **Auto**.
4. Highlight **Auto Interval (min)** and select an interval.

Note After you invoke an automatic NIBP, expect a delay before the monitor starts the first measurement. The delay can be as long as the interval selected.

To stop automatic NIBP readings

1. Highlight **NIBP** and press .
2. Highlight **NIBP Mode** and select **Manual**.

Taking NIBP readings using Turbo mode

In Turbo mode, the monitor starts an NIBP reading and then takes as many more readings as possible within five minutes.

To use the Turbo mode

1. Select and apply the NIBP cuff and hose. (“[Monitoring blood pressure \(NIBP\)](#)” on page 65.)
2. Highlight **NIBP** and press .
3. Highlight **NIBP Mode** and select **Turbo**.

Note If you cycle the monitor power, NIBP returns to auto mode.

To end the Turbo mode

Press  or select **NIBP Mode Manual**. The monitor returns to Auto NIBP measurement mode.

NIBP measurements in power-saving mode

When a manual or turbo NIBP activity awakens the monitor from power-saving mode (“[Power saving](#)” on page 44), cuff inflation pressure is reset to default levels and cuff inflation is delayed for up to 8 seconds.

NIBP disabled when the battery is low

If the battery is low and the monitor is operating on battery power, NIBP functions are disabled and the monitor displays the message “NIBP off. Low battery.”

If you attempt to start an NIBP measurement during a low-battery condition, the monitor displays an equipment alert with the message “Low battery. NIBP disabled.”

Note Inserting a monitor into a powered cradle during a low-battery condition immediately enables NIBP monitoring.

Changing the default settings

You can change the default settings (the monitor configuration) using the following methods:

- Save the current settings as the new default settings.
- Restore the last downloaded configuration.
- Restore the factory settings.

- Download another configuration from a PC. (See “Using the Configuration Utility to configure the monitor” on page 116.)

To save the current settings as the new default settings

1. Access the Configuration Setup menu.

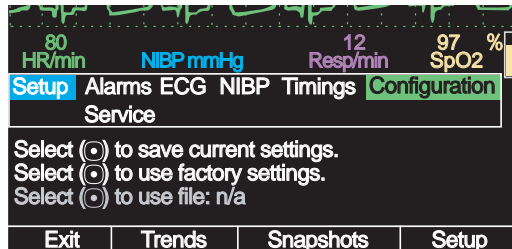

2. Highlight **Select (C) to save current settings** and press (C).
3. In the confirmation screen, highlight **Confirm** and press (C).

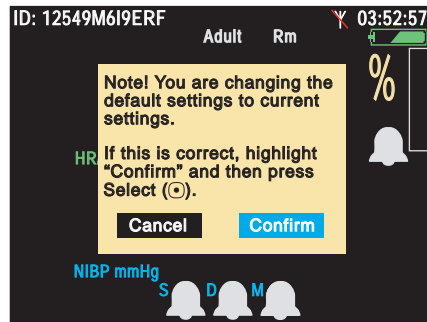

To restore the last downloaded configuration

1. Access the Configuration Setup menu, highlight **Select (A) to use file: configuration_file_name**, and press (A).
2. In the confirmation screen, highlight **Confirm** and press (C).

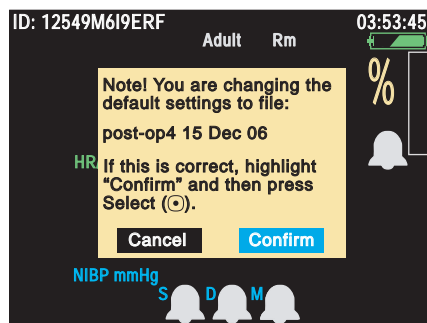

To restore the factory configuration

1. Access the Configuration Setup menu, highlight **Select (F) to use factory settings**, and press (F).
2. In the confirmation screen, highlight **Confirm** and press (C).

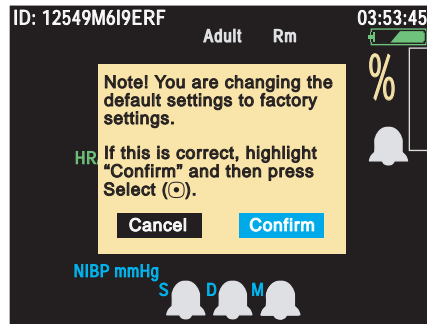

To discontinue monitoring

1. Press . The Power Off screen appears.

Figure 76. Power-off

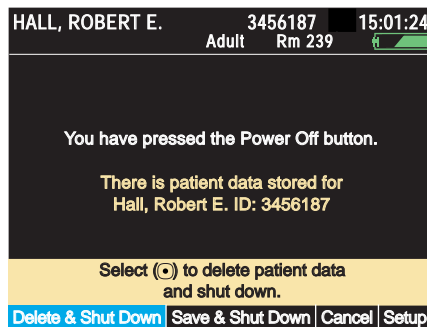

- If you intend to continue monitoring the same patient when the monitor is turned on again, and if you want to save the stored vital-signs data and monitor settings (to print them at a PC), highlight **Save & Shut Down** and then press . The monitor saves the patient data and the monitor settings, and then turns off.
 - If you do not intend to continue monitoring the same patient when the monitor is turned on again, highlight **Delete & Shut Down** and then press . The monitor turns off without saving the data and the settings.
2. Disconnect the leads and sensors from the patient.

If you press and then decide that instead of turning off the monitor you want to resume monitoring the same patient, do one of the following:

- Highlight **Cancel** and press .
- Wait for 30 seconds.
- Press .

Note When you power down from Demo mode, you cannot save settings and patient data.

4

Monitoring in communication with Acuity

About wireless monitoring

The model 802LTAN, 802LTAS, 802LTRN and 802LTRS wireless monitors can operate either in standalone mode or in communication with a Welch Allyn Acuity Central Station. (See “[Standalone monitoring](#)” on page 47.)

While the wireless monitor is connected to the FlexNet network, patient data gathered by the monitor is continuously stored at Acuity. At the Acuity station you can access this patient information and perform administrative functions, including the following:

- Admit, transfer, and discharge a patient in the Acuity unit.
- Edit the patient description (name, physician, and so on).
- Review and print patient data such as trends and waveforms.

For more information about Acuity and the FlexNet wireless network, refer to *Acuity directions For use*.

For Model 802LTAN and 802LTAS monitors, the radio, by default, authenticates against the WA RADIUS server running on an Acuity Central Station. If the hospital IT department requires a different authentication/encryption solution, then the monitor, using the factory-default radio configuration, cannot connect to the network.



WARNING When monitoring a patient who has a pacemaker, position the monitor to maintain a minimum distance of 6 inches (16 cm) between the monitor and the pacemaker. **If you have any reason to suspect that the monitor is interfering with the pacemaker, immediately turn the monitor off and provide appropriate patient care.** The Health Industry Manufacturers Association recommends this minimum distance (6 inches or 16 cm) between a hand-held wireless radio and a pacemaker, which is consistent with the independent research by, and recommendations of, Wireless Technology Research.

WARNING When considering a treatment protocol that involves wireless communication of patient data, be aware of this limitation:

When the monitor is *not* connected to the network by wireless connection:

Acuity does not receive patient alarms or alerts from the monitor.

Acuity does not perform arrhythmia and ST analysis on patient data and therefore does not generate related alarms.

WARNING If you establish a USB link to any active host while the monitor is in network communication with Acuity, the wireless connection is lost.

Note When the monitor is used in Canada:

To provide maximum shielding (to prevent radio interference to the licensed service), the monitor is intended to be operated indoors and away from windows. Radio equipment (or its transmit antenna) that is installed outdoors is subject to licensing.

Afin de fournir un écran de blindage maximal (pour empêcher que cet appareil cause du brouillage au service faisant l'objet d'une licence), l'appareil doit être utilisé à l'intérieur et devrait être placé loin des fenêtres. Si le matériel (ou son antenne d'émission) est installé à l'extérieur, il doit faire l'objet d'une licence.

Establishing communication with Acuity

If the monitor is enabled for communication with Acuity, communication is established automatically whenever the monitor is within range of the network. The monitor always indicates the status of the connection:

Figure 77. Connection status indicator

(blank) The monitor is not enabled for communication with Acuity.



The monitor is communicating via USB cable with a PC.



The monitor is associated with the network and is communicating with Acuity.



(Flashing) The monitor is associated with the network but is not communicating with Acuity.



(Continuous) The monitor is not associated with the network and is not communicating with Acuity.



Verify that the monitor, within a minute or two, displays  to indicate that the connection to Acuity has been established.

Upon connecting to the network, the monitor uploads the following data to Acuity:

- Patient information and trends stored at the monitor before the network connection was established
- Monitor settings

At the same time, Acuity downloads some configuration settings to the monitor. (See [“About Acuity-defined configuration”](#) on page 104.)

For information on monitoring vital signs, see the following:

ECG/Resp [“Monitoring ECG and Resp”](#) on page 52

SpO₂ [“Monitoring SpO₂”](#) on page 60

NIBP [“Monitoring blood pressure \(NIBP\)”](#) on page 65

Monitoring a patient outside of network range

Monitors are typically deployed in an active wireless network environment where devices continually communicate with a central station. These monitors occasionally leave the wireless coverage area during transport to a procedure room (for example, a trip to X-ray). When a monitor goes outside of the network range, monitoring continues locally.



Caution Be aware that moving the monitor out of the Acuity network range breaks the radio link, immediately stopping communication of patient vital-signs data.

The monitor provides local Resp, NIBP, HR/PR and SpO₂ alarms or equipment alerts. The following also happens:

- An alert occurs at Acuity with the message DROPOUT.
- An alert occurs at the monitor with the message Check Acuity/network connection.
- The monitor emits audible alert tones.
- The appropriate caregiver presses  to acknowledge the alert.

When the monitored patient is again within range of the Acuity network, the monitor reconnects to the network and wireless monitoring resumes.



Caution Be aware that it can take as long as three minutes to restore communication with the Acuity network and resume the communication of patient vital-signs data.

Note When communication with the Acuity network is re-established, the monitor uploads trends data, but not snapshot data, to Acuity.

Patient monitor behavior during operation outside of wireless network coverage areas

When the monitor leaves a wireless coverage area, it can exhibit the following characteristics:

- The monitor aggressively searches to locate the wireless Acuity network.
- The monitor consumes battery life at a faster rate, which reduces the battery operating time.
- If the monitor remains out of range of the Acuity network for several minutes, the radio enters a low-power state.
- If disconnected for longer than four hours, the monitor might generate a system fault error that would necessitate a reset (power cycle) of the monitor.



Caution Do not leave a wireless monitor that is turned on outside of its wireless communication area for more than four hours.

If your facility has unusual clinical workflows that require wireless devices to be off of the network for extended periods, do one or more of the following:

- Extend the wireless coverage area to include areas where devices stay for longer periods of time. For example, include wireless coverage in the Post Cardiac Cath, X-Ray, and MRI areas.
- When a monitor moves to a stand-alone environment, configure the device in the stand-alone mode. This disables the radio card for use in the stand-alone work environment.
- Before removing monitors from a wireless coverage area, disconnect them from the wireless infrastructure. Propaq LT monitors include this software feature for clinicians.

About Acuity message menus

When the monitor first establishes communication with Acuity and the clinician selects to start a new patient, the monitor presents a series of screens to determine the location (unit and room number) and the name and ID number of the monitored patient. If the patient is already known to Acuity, you can select the identifying information from a series of lists. If the patient is new to Acuity, you provide the information.

If the clinician is continuing to monitor the same patient, these Acuity message menus are not presented.

Note Some of these menus can contain lists that are too long to fit on the screen. To view or highlight list items that are not on the screen, press ▲ or ▼ repeatedly as needed scroll the list.

First, the monitor displays a list of units. Highlight the unit for this patient and press Ⓞ.

Figure 78. Acuity unit list

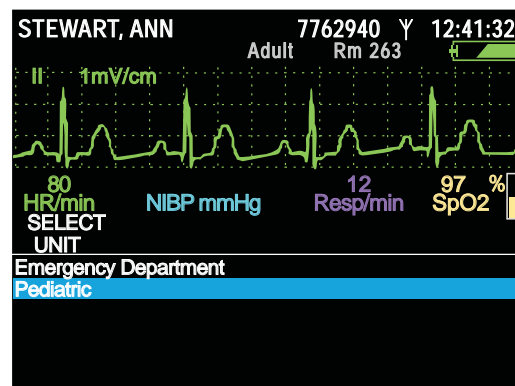

The monitor then displays a list of patients.

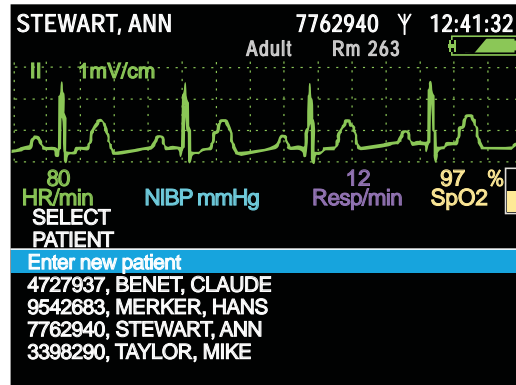
Figure 79. Acuity patient list

- If the patient's name is already on the list, highlight the name and press **⊙**.
- If it is not, highlight **Enter new patient**, press **⊙**, and use the information entry screen (Figure 48 on page 49) to enter the patient's name and/or ID number (if either is known).

If you select the name of an existing patient, the monitor displays a list of rooms. Select the patient's room.

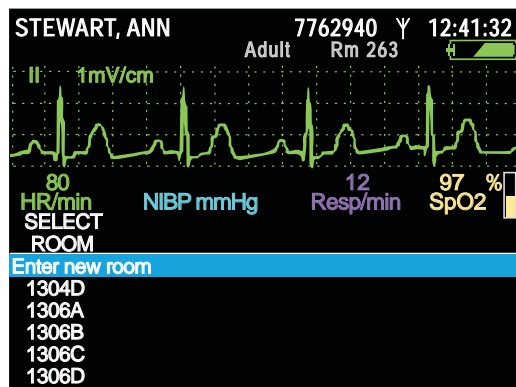
Figure 80. Acuity room list

If communication is interrupted during monitoring

If communicated monitoring has begun and communication is then interrupted, the monitor displays an alert message.

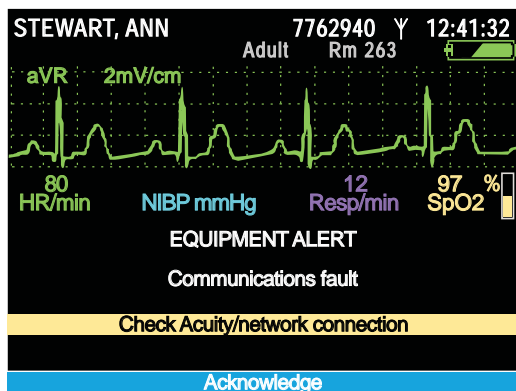
Figure 81. Alert message: Communications Fault

Press to clear the message.

When the monitor re-establishes communication with Acuity (after an interruption of at least 30 seconds), it prompts you to confirm that the patient being monitored is the same patient that was being monitored when communication was interrupted.

Figure 82. Same Patient query

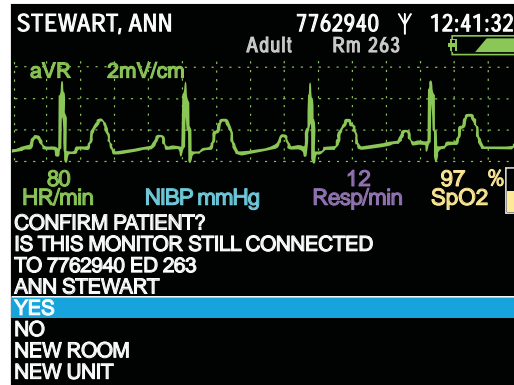

Note If the communication interruption lasts less than 30 seconds, or if you save, cycle power, and reestablish communication within 30 seconds, this confirmation is not required.

Press to confirm.

To access the Acuity menu after connection has been established

1. Highlight and press . The Wireless mode popup menu appears (Figure 84).

Note Depending on the level of network traffic, some interactions between the monitor and Acuity can take a few seconds to complete.

2. Highlight **Acuity menu** and press .

Figure 83. Acuity menu

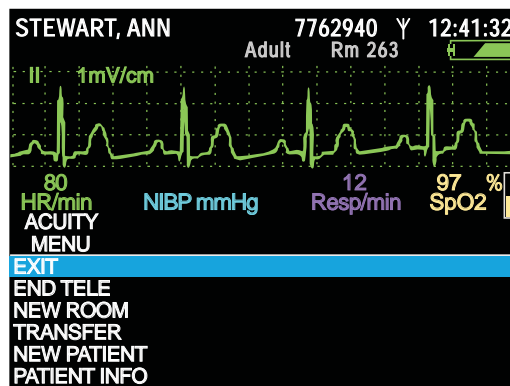

You can use the Acuity menu (Figure 83) to end the telemetry session (END TELE), assign the patient to a new room (NEW ROOM), transfer the patient to another unit (TRANSFER), enter the name and ID of a new patient (NEW PATIENT), or update the information for the current patient (PATIENT INFO).

To close the Acuity menu, highlight **EXIT** and press .

To disconnect from the network

Note Disconnecting the monitor from the network while the monitor is outside of network range greatly extends battery life. However, connection with the network must first have been established before this is possible.

1. Highlight Ψ and press \odot .
2. Highlight **Disconnect**, press \odot , and confirm.

Figure 84. Wireless Mode: Disconnect

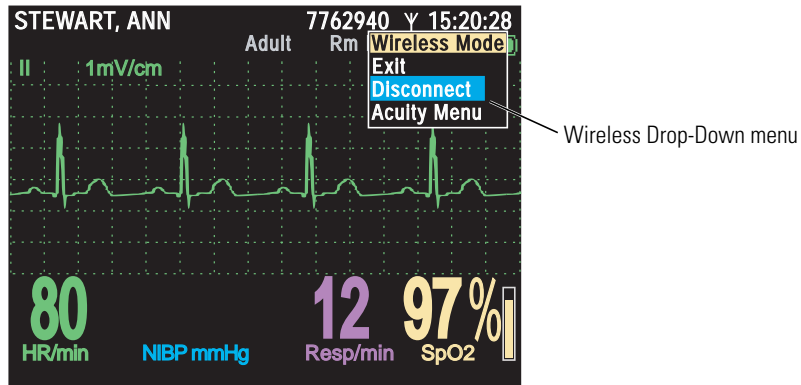

Ψ changes to Ψ and the message 'DISCONNECTED' appears, alternating with the patient ID number.

Figure 85. Patient disconnected from the network

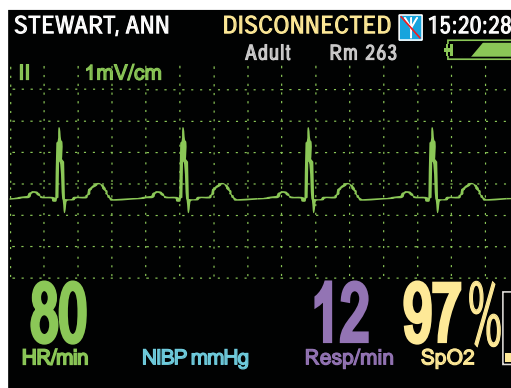

Note If you disconnect from the network and then turn off the monitor before reconnecting, and if you then select **Continue Patient** when you again turn on the monitor, the monitor powers up in the disconnected state.

To reconnect a patient to the network

1. Highlight Ψ and press \odot .
2. Highlight **Reconnect** and press \odot .

The monitor prompts you for information about the connection and the patient.

3. Provide the information requested.

5

Alarms and alerts

Overview

An **Alarm** warns of a patient condition, such as a vital-sign reading that is outside of acceptable limits. When an alarm occurs, the red light on the monitor flashes and the numerics of the violating alarm limits on the display turn red. If tones are not suspended, the alarm tone sounds.

An **Alert** warns of an equipment condition, such as a low battery or a detached lead. When an alert occurs, the yellow light on the monitor flashes and a message describing the error condition appears on the display. If tones are not suspended, the alert tone sounds.

Alarms have priority over alerts. If an alarm and an alert are detected simultaneously, the monitor notifies you of the alarm. It then notifies you of the alert only if the alert condition still exists after the alarm condition is removed.

Silencing an alarm or alert tone

A tone sounds whenever the monitor detects an alarm or alert condition.

To silence the currently sounding tone for 90 seconds

1. Press .

Note Silencing the tone does not affect the other alarm or alert indicators.

- The red light (alarm) or the yellow light (alert) flashes.
- After 90 seconds, if the condition is not corrected, the tone starts again.
- If the condition is corrected within 90 seconds of silencing the tone, the monitor resets the tones for the next alarm or alert.

If a new alarm or alert condition occurs while an earlier alarm or alert is silenced, the tone sounds again.

Figure 86. Sample alarm screen

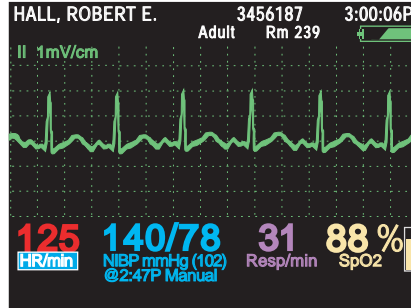
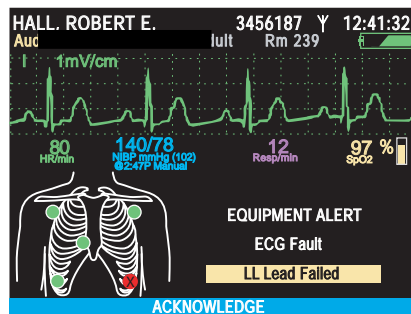



Figure 87. Sample alert screen



2. Check the patient and provide appropriate care.
3. Press  to silence the audible tone for 90 seconds at the monitor and at Acuity.
 - Silencing the audible tone does not remove visual alarm or alert indications.
 - Silencing the audible tone causes an alarm or alert suspend at Acuity.
 - When the alarm or alert condition is corrected, all alarm or alert indicators cease and all alarms are immediately rearmed.
4. After caring for the patient, verify that alarm limits are enabled and correctly set.



WARNING If you turn off or modify any alarm limits while responding to an alarm, restore those alarm limits before you resume monitoring.

Suspending the alarm tone

If this feature is enabled in the monitor configuration (See “[Monitor configuration](#)” on page 103), you can suspend all alarm tones for all parameters—preventing the alarm tone from sounding if an alarm condition occurs—while monitoring a patient. If an alarm condition occurs while the alarm tones are suspended, the monitor presents visual alarm indicators but does not sound the tone.

In the monitor configuration, the alarm tone suspension period can be set to **Disabled**, to **Always On**, or to a period: **90 sec** or **2, 3, 4, 5, 10, 15, 30**, or **60** minutes.

Note The factory default suspension period is **4 minutes**.

- If it is configured to **Disabled**, you cannot suspend the alarm tone at the monitor.

- If it is configured to **Always On** and you set **Suspend Audible Alarms** to **On**, then the alarm tone remains suspended until:
 - you set **Suspend Audible Alarms** to **Off** or
 - monitor power is turned off and then turned on again or
 - the monitor is reconfigured

Note **Suspend Audible Alarms** does not affect the behavior of the **alarm silence/reset** feature (⏏). Pressing ⏏ always either silences a sounding alarm tone for 90 seconds or resets the audible alarm if it was already silenced.

To suspend the alarm tone

1. Access the Setup menu. (See “To access the setup menus” on page 37.)
2. Highlight **Suspend Audible Alarms**.

Figure 88. Suspend Audible Alarms: Off

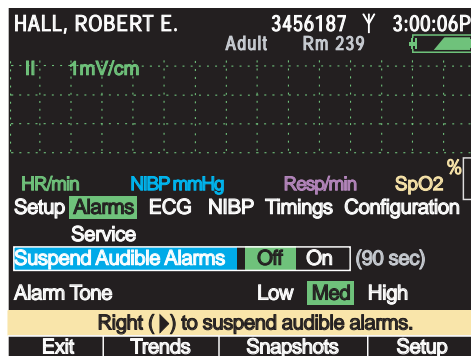

The configured suspension period—90 seconds in this example—is displayed to the right of the line.

3. Highlight **On**.

Note If audible alarms are suspended, pressing ⏏ cancels the suspension.

Figure 89. Suspend Audible Alarms: On

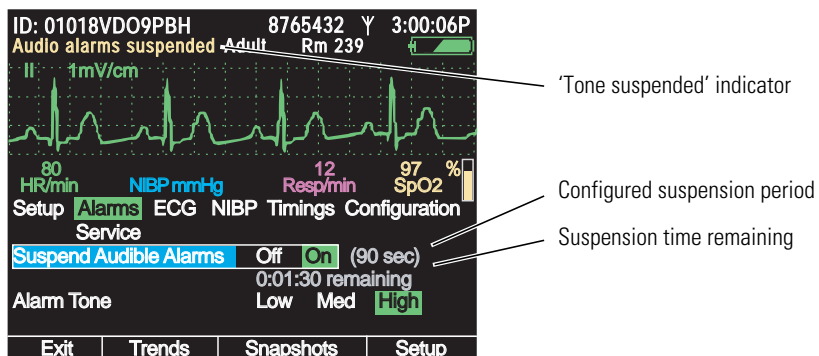

- The alarm tone is suspended immediately.
 - If an alarm condition occurs during the suspension period, the alarm tone does not sound.

- A countdown timer appears below the line to indicate the time remaining in the suspension period.
- 'Audio alarms suspended' appears in yellow in the upper left corner of the screen.
- When the suspension period elapses, the alarm tone is again enabled.

Changing alarm limits

At the monitor

Typically, each institution determines the appropriate alarm limits for adult, pediatric, and neonatal patients and then configures the monitor with those alarm limits before putting the monitor into service. These become the default alarm limits for the monitor—the alarm limits used each time the monitor is powered on.

The configured alarm limits remain in effect until the monitor configuration is changed. However, you can temporarily change the current patient's alarm limits.

To temporarily change alarm limits for the current patient

1. Highlight the vital sign for which you want to set custom limits.
2. Press \odot .
3. Highlight the limit you want to change.
4. Set a new alarm limit.

Figure 90. Changing alarm limits for the current patient

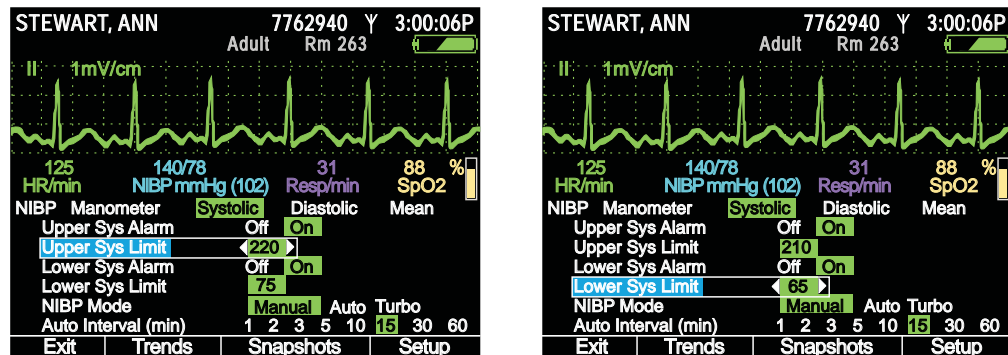

5. Repeat from [step 3](#) for other alarm limits you want to change for the same vital sign.
6. Press \odot .

When the monitor is turned off, you will have a choice of saving the current settings and stored patient data or deleting the current settings and patient data. Neither choice affects the default settings for the monitor.

At Acuity

For a wireless monitor, patient alarm limits can also be customized from Acuity. (See the user manual supplied with any Acuity Central Monitoring Station.)

About ParamSet

Using ParamSet, you can quickly widen the alarm limits by a configured percentage (relative to the patient's alarming reading) for any vital sign.

For information about ParamSet, see "ParamSet Settings" on page 133.

Responding to an alarm

An alarm condition is indicated on the monitor in the following ways:

- The RED indicator (rightmost of three) above the display screen flashes.
- The numerics for the vital sign in alarm are displayed in RED.
- If alarm tones are not suspended, the alarm-tone sequence sounds repeatedly—3 short tones, a short pause, 2 short tones, and a long pause.

Responding to an alert

An alert condition ("Overview" on page 81) is indicated on the monitor in the following ways:

- A flashing yellow light above the monitor display.
- A yellow alert message on the monitor display (for example, NO ECG CABLE DETECTED).
- Repeated sounding of the alert-tone sequence (if tones are not suspended): 3 long tones and a pause.

Figure 91. Example alert screen

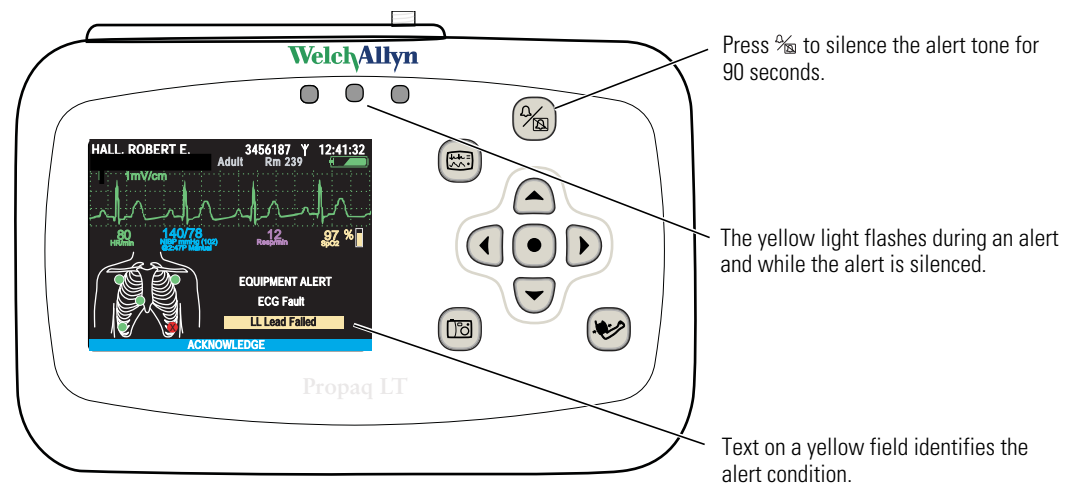

To respond at the monitor to an alert







1. Press to silence the tone for 90 seconds; press to clear the alert.
2. Troubleshoot and correct the problem. (See "Alert messages and status messages" on page 87.)

To respond at Acuity to an alert

For a monitor in communication with Acuity, either the monitor or Acuity can detect alarms and alerts. The alarms are displayed in both places. See *Acuity Directions For use*.

About battery charge status

Table 6. Battery status indicators

Display	Status/alert text	Battery	Monitor	Recommended action
 Green		Fully charged	Okay	None
 Green		Partially full	Okay	None
 Green		Partially full; charging	Okay	None
 Yellow	EQUIPMENT ALERT Low Battery. Charge battery soon.	Low	Can function for up to 30 minutes, but NIBP is disabled.	Prepare to discontinue monitoring. If possible, insert the monitor into a cradle.
 Yellow		Low; charging	Normal function.	Do not remove the monitor from the cradle.
 Red	EQUIPMENT ALERT Battery Too Low. Shutting down.	Almost completely discharged	Shutting down soon. Can function for up to 5 minutes, but NIBP is disabled.	Prepare to discontinue monitoring. If possible, insert the monitor into a cradle. If this indicator appears when the monitor is in a powered cradle, then the battery is damaged and must be replaced. In this case, all stored patient data will be deleted when the monitor is removed from the cradle.
 Red		Almost completely discharged; charging	Normal function.	Do not remove the monitor from the cradle.

Alert messages and status messages

Table 7. Alert messages

Alert type	Message	Possible cause and suggested response
ECG	ECG Fault. XX lead failed.	Lead XX (LA, LL, RA, C, or RL) has very poor contact or no contact with the patient. Check for proper connection and replace the electrode if needed.
	ECG Fault. XX, XX leads failed.	Leads XX and XX (any two leads on a 5-lead cable) have very poor contact or no contact with the patient. Check for proper connection; replace electrodes if needed.
	ECG Fault. Multiple lead fail.	At least three leads of a 5-lead cable or at least two leads of a 3-lead cable have very poor contact or no contact with the patient. Check for proper connection; replace electrodes if needed.
	ECG Fault. Excessive offset.	At least one channel has excessive offset. At least one electrode is old, contaminated, or defective. Replace the electrodes.
	ECG Fault. Cable disconnected.	The ECG cable is unplugged.
NIBP	NIBP Fault. Air leak. Check hose.	The monitor could not properly inflate the cuff. Check the hose and cuff for leaks.
	NIBP Fault. Kinked hose. Check hose.	The monitor could not properly inflate the cuff. Check for a hose kink between the monitor and the patient.
	NIBP Fault. Overpressure condition.	The pressure in the cuff exceeded the acceptable limits for the current patient mode. Check the hose and retry the measurement.
	NIBP Fault. Weak Pulses. Can't find Sys/Dia.	Not enough pulses to determine the systolic or diastolic pressures, but a mean pressure is available. Squeeze all air from the cuff and reapply it.
	NIBP Fault. Artifact. Can't find Sys/Dia.	The systolic or diastolic pressures are unreliable due to artifact, but a mean pressure is available. Usually caused by patient motion.
	NIBP Fault. No pulses detected.	The cuff might not be properly applied to the patient, or the patient might not have detectable pulses due to shock or arrhythmias.
		 WARNING The monitor cannot determine whether this alert has a physiologic cause or a cuff application cause. Always evaluate the patient for presence of life-threatening conditions when this message occurs.
NIBP Fault. Connect ECG to reduce NIBP artifact.	NIBP artifact prevents a valid reading. Connect ECG electrodes to improve NIBP measurements. (See "Improving NIBP accuracy with Smartcuf" on page 68.)	

Table 7. Alert messages

Alert type	Message	Possible cause and suggested response
	NIBP Fault. No valid blood pressure found.	The patient mode setting is incorrect or the wrong hose or cuff is being used for the current patient mode.
	NIBP Fault. Calibrating. Please wait.	The monitor periodically calibrates (zeroes) the NIBP channel to make sure it can properly make NIBP measurements. No NIBP monitoring can be done until the calibration is completed. Other normal monitor operation continues during NIBP calibration.
	NIBP Fault. Calibrating. Minimize motion.	Motion is detected during a periodic NIBP calibration. Minimize patient motion or motion on the cuff, or disconnect the cuff. Motion-generated noise on the pressure transducer can cause the calibration to continue indefinitely.
	NIBP Fault. Low battery. NIBP disabled.	The battery is too far discharged to operate the NIBP channel. Insert the monitor into a powered cradle.
	NIBP Fault. Service required. NIBP disabled.	Have the monitor serviced.
	NIBP Fault. Kinked or neonate hose.	A hose is kinked or a neonate hose is detected in the adult patient mode. Check the hose and the patient mode selection.
	NIBP Fault. Artifact present. Minimize motion.	The monitor has detected too much artifact to allow accurate readings. Take steps to reduce artifact. Position the patient's limb away from the body so the applied cuff is not in contact with the patient's body or any other object such as a bed rail.
Network Communication	Comms Fault. Check Acuity/network connection.	The monitor detects a network communication problem.
	Comms Fault. Check USB connection.	The monitor detects a problem in communication with the cradle. Detach and reattach the USB cable.
	Not on Network. Patient info entry not allowed.	You attempted to select the Name, ID, or Rm field on an Acuity-enabled monitor that is not connected to the network.
Battery	Low Battery. Charge battery soon.	The monitor battery charge is low, and the monitor will shut down in 30 minutes or less. Insert the monitor into the cradle. If no cradle is available, find an alternative method of monitoring the patient before the monitor shuts down.
	Very Low Battery. Charge battery now.	The monitor battery charge is very low; the monitor will shut down in 5 minutes or less. Insert the monitor into a cradle or find another way to monitor the patient before the monitor shuts down.
	Battery Too Low. Shutting down.	The monitor battery charge is too low to support monitor function. Monitor operation can continue only after the battery is recharged or replaced or until the monitor is inserted in a powered cradle.

Table 7. Alert messages

Alert type	Message	Possible cause and suggested response
Charger	Charger Fault. Service charger.	Service required.
	Charger Disabled. Battery temperature too high or low.	The battery is too cold or too hot to charge. Normalize the battery temperature before attempting to charge it.
	Battery Fault. Replace battery.	The battery is missing; the battery is discharged too far to be charged; the charger has timed out; a cell in the battery pack is overcharged due to cell imbalance; the fuse is blown. Service required.
SpO ₂	SpO ₂ Fault. No sensor detected.	An SpO ₂ sensor has been disconnected from the monitor after being connected for more than a few seconds.
	SpO ₂ Fault. Defective SpO ₂ sensor.	Replace the sensor.
	SpO ₂ Fault. Defective SpO ₂ sensor/ No sensor detected.	Replace the sensor.
Masimo only	Ambient light.	Too much light on the sensor site. Verify that the sensor shield is covering the site and, if necessary, reduce the ambient light, shade the sensor site, or replace the sensor.
	Sensor off.	The sensor is not properly attached to the patient; reconnect it to the monitor and reattach it to the patient. If the sensor is properly attached, it is defective; replace it.
	Interference.	An outside signal or outside energy is preventing the reading. Remove the interference.
Resp	Resp Fault. Lead fail.	One or more electrodes have very poor or no contact. Check for proper connection; replace electrodes if needed.
	Resp Fault. Noisy signal. Check electrodes.	Electrodes have poor contact and might be dried out. Replace electrodes.
	Resp Fault. Inappropriate ECG cable.	The ECG cable does not contain 1 k Ω current-limiting resistors, which are required for Resp operation and to protect the monitor from damage during defibrillation. Replace the cable with one of the proper type.
General	Multiple Faults.	Multiple equipment alerts have been triggered simultaneously.

 **WARNING** If you acknowledge this alert message before determining which alerts are triggered, you cannot identify individual alerts.

Table 8. Status messages

Message	Notes
Audio alarms suspended.	
Some alarms off.	At least one alarm is turned off.
Press Select (●) for controls.	
NIBP off. Low battery.	The battery is too low; NIBP monitoring is disabled.
Snapshot in progress.	
NIBP in progress.	

Table 8. Status messages

Message	Notes
NIBP calibrating.	The monitor will resume operation when the calibration is complete.
Button pad locked.	Buttons (including the on/off button) remain locked until you unlock them or until an alarm or an alert sounds.
Check SpO2 sensor.	The sensor cable is faulty, incorrectly inserted, or incompatible. This message persists until a valid cable is connected or until monitor power is cycled.
Retry in progress.	An NIBP automatic retry is in progress.
Low perfusion index.	Masimo only.
SpO2 interference.	Masimo only.
SpO2 sensor off.	Masimo only.
SpO2 ambient light.	Masimo only.
Low Signal IQ.	Masimo only.

6

Storing and reviewing patient data

Overview

The monitor stores up to 24 hours (at one-minute intervals) of trends information for the patient being monitored. When data storage is at capacity, the data from each new reading replaces the data from the oldest.

Table 9. Store and review patient data

	All monitors	Wireless monitor
Type of data	<p>TRENDS</p> <ul style="list-style-type: none"> • Tabular or graphical. • Include maximum of 24 hours of trend data taken at: <ul style="list-style-type: none"> 1-minute intervals NIBP and SpO₂ Spot Checks Snapshots <p>SNAPSHOTS</p> <ul style="list-style-type: none"> • 21 seconds of numeric and waveform data: 14 seconds before and 7 seconds after the snapshot request. • Press  to take snapshots. (Maximum: 5 snapshots per minute.) • Maximum of 20 snapshots stored. At capacity, each new snapshot overwrites the oldest. 	<p>Up to 96 hours (depends on Acuity system) of full disclosure data includes:</p> <ul style="list-style-type: none"> • numerics and waveforms • status
Where stored	Monitor	Acuity via wireless communication
Where reviewed	Monitor Printer (with AutoPrint)	Acuity

Capturing a data snapshot

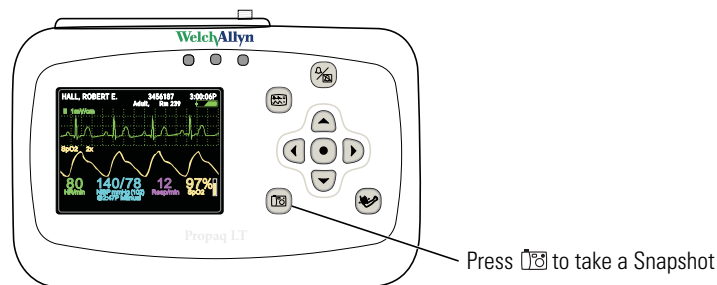

Press  to capture a 21-second period of numeric and waveform patient data. The monitor captures the 14 seconds preceding and the 7 seconds following the button press.

The monitor can store 20 snapshots. After 20 snapshots have been taken, each new snapshot replaces the oldest snapshot in memory.

Reviewing data at the monitor

Snapshots and trend data can be reviewed at the monitor.

Reviewing snapshots

To review snapshots

From any main display screen (such as Large numerics, Dual waveform...):







1. Highlight , **HR/PR**, **SpO2**, **NIBP**, **Resp**, or .
2. Press .
3. Highlight **Snapshots** and press . The Snapshots display appears.

Figure 92. Snapshots display

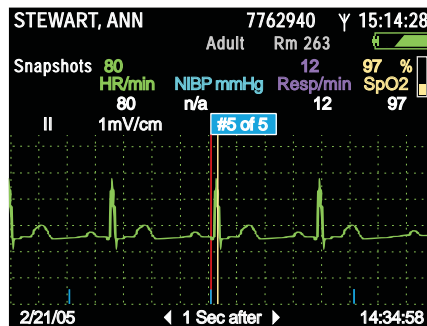

4. The monitor first displays **Select**. With **Select** highlighted, press  to view the list of up to 20 snapshots. To view another snapshot, highlight the snapshot menu (**#5 of 5** in the example above), press , and highlight any of the available snapshots.

The blue markers at the bottom of the waveform display represent one-second intervals. The numeric data above the waveform represents the patient's vital signs measured at a specific time relative to that indicated in the lower right corner. For example: In [Figure 92](#), the data was measured at "1 Sec after" 14:34:58.



5. To view the waveform and the numeric data for a specific time within the 21 seconds of data, highlight **1 Sec after** and then use  or  scroll the display to the desired time. For example, to see the vital signs taken five seconds after the trigger point of the snapshot, highlight **1 Sec after** and press and hold  as needed to increment the display to **5 Sec after**.

Figure 93. Snapshots display: 5 seconds after the button press



6. To change the source of the displayed waveform, see “To change the waveform selection” on page 55.
7. To change the size of the waveform, see “To change the waveform size” on page 56.
8. From this display, you can switch to another type of display or you can exit and return to the primary display. To do this, highlight **Snapshots** and press \odot . The Trends menu appears, from which you can exit or switch to another display—Tabular, Tabular and Waveform, or Graphical. To switch to the split display, for example, highlight **Tab/Wave** and press \odot .

Figure 94. Snapshots display: switching to another display

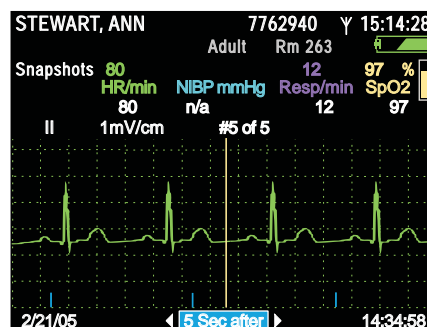
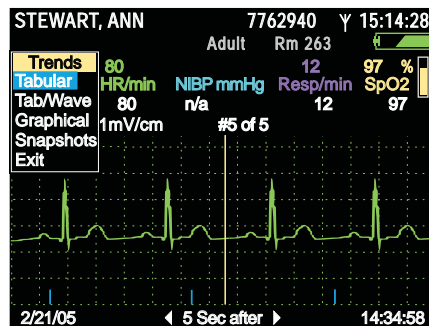

Reviewing trends

To review trends

From any main display screen (such as Large Numerics, Dual Waveform...):

1. Highlight HR/PR , SpO2 , NIBP , Resp , or SpO2 .
2. Press \odot .
3. Highlight **Trends** and press \odot . The Trends display appears.

Use \blacktriangle and \blacktriangledown to scroll through the list of trends.

- Red indicates an alarm.
- [Snapshot Icon] indicates that a snapshot exists for this trend. Highlight [Snapshot Icon] and press \odot to view the snapshot.
- $\text{[Overwritten Snapshot Icon]}$ indicates that the snapshot for this trend was overwritten with a more recent snapshot and is not available for viewing.
- --- indicates a value below the monitor's measurement range.
- +++ indicates a value above the monitor's measurement range.
- ??? indicates an undetermined value.

Figure 95. Trends display, 1-minute interval

STEWART, ANN 7762940 ♀ 04:45:10P				
Adult Rm 263				
Tabular	59	120/72(88)	14	98 %
Time	HR/min	NIBP mmHg	Resp/min	SpO2
4:42P	60	n/a	14	99
4:41P	58	n/a	13	98
4:40P	59	n/a	14	98
4:40P	59	n/a	14	99
4:39P	60	n/a	13	98
4:39P	60	118/71(87)	14	98
4:38P	59	n/a	14	98
4:37P	60	n/a	14	99
4:36P	60	n/a	13	98
4:35P	60	n/a	14	98
4:35P	60	n/a	13	99
4:34P	59	119/72(88)	13	98

4. Highlight and view any available reading in tabular or graphical format.

Changing the trends display interval

To change the trend display interval

1. Highlight **Time** and press **⊙**.

Figure 96. View interval menu, 1-minute interval selected

STEWART, ANN 7762940 ♀ 04:45:12P				
Adult Rm 263				
Tabular	59	120/72(88)	14	98 %
View Interval	HR/min	NIBP mmHg	Resp/min	SpO2
1 min	n/a	n/a	14	99
5 min	n/a	n/a	13	98
10 min	n/a	n/a	14	98
15 min	n/a	n/a	14	99
30 min	n/a	n/a	13	98
60 min	n/a	n/a	14	98
4:38P	59	118/71(87)	14	98
4:37P	60	n/a	14	98
4:36P	60	n/a	13	98
4:35P	60	n/a	14	98
4:35P	60	n/a	13	99
4:34P	59	119/72(88)	13	98

2. Highlight the interval you want...

Figure 97. View interval menu, 10-minute interval highlighted

STEWART, ANN 7762940 ♀ 04:45:15P				
Adult Rm 263				
Tabular	59	120/72(88)	14	98 %
View Interval	HR/min	NIBP mmHg	Resp/min	SpO2
1 min	n/a	n/a	14	99
5 min	n/a	n/a	13	98
10 min	n/a	n/a	14	98
15 min	n/a	n/a	14	99
30 min	n/a	n/a	13	98
60 min	n/a	n/a	14	98
4:38P	59	118/71(87)	14	98
4:37P	60	n/a	14	99
4:36P	60	n/a	13	98
4:35P	60	n/a	14	98
4:35P	60	n/a	13	99
4:34P	59	119/72(88)	13	98

3. ...and press **⊙**.

Figure 98. Trends display, 10-minute interval

STEWART, ANN		7762940		Y 04:45:17P	
	Adult	Rm 263			
Tabular	60	119/72(88)	14	98	%
Time	HR/min	NIBP mmHg	Resp/min	SpO2	
4:40P	59	n/a	13	98	
4:40P	59	120/72(88)	14	98	
4:39P	60	n/a	13	98	
4:35P	59	120/72(88)	14	98	
4:30P	58	119/71(87)	14	99	
4:20P	60	120/72(88)	14	98	
4:10P	59	120/71(88)	14	98	
4:00P	60	n/a	13	98	
3:59P	59	119/71(87)	14	98	
3:50P	59	119/72(88)	14	98	
3:40P	60	118/71(87)	13	99	
3:30P	60	120/71(88)	14	99	

Measurement anomalies in the trends display

Figure 99. Trends display with measurement anomalies

STEWART, ANN		7762940		Y 04:45:10P	
	Adult	Rm 263			
Tabular	59	120/72(88)	14	98	%
Time	HR/min	NIBP mmHg	Resp/min	SpO2	
4:42P	60	192/110(130)	14	99	
4:41P	58	n/a	13	98	
4:40P	59	n/a	14	98	
4:40P	59	n/a	14	98	
4:39P	60	n/a	13	98	
4:39P	+++	x118/71(87)	14	98	
4:39P	60	n/a	14	98	
4:37P	60	n/a	14	99	
4:36P	---	???/??(???)	13	98	
4:35P	60	n/a	14	98	
4:35P	60	n/a	13	99	
4:34P	59	119/72(88)	13	98	

+++	Measurement above monitor limits for the parameter.
---	Measurement below monitor limits for the parameter.
???	Measurement undetermined.
red text	Patient alarm condition.

Reviewing data at a PC

See "Printing patient data" on page 97.

Reviewing data at Acuity

See the *Acuity Directions For use*.

7

Printing patient data

Overview

You can print patient data in two ways.

- If the monitor is in communication with an Acuity Central Station, press **Ⓞ** to print vital signs at the Acuity system printer.
- If a PC with the Autoprint Utility is connected to a cradle with the USB option, you can print directly to a printer connected to the PC simply by inserting the monitor in the cradle.

This chapter tells you how to print with the Autoprint Utility.

The AutoPrint utility uploads from the monitor to the PC, either manually or automatically, trend data and snapshots stored by the monitor for the current or most recent patient. The PC then prints the data on the configured laser printer.

Note Use only a laser printer. The monitor can store a large amount of data. If you use any other type of printer, it can take a long time to print all of the data.

Note If you attempt to print patient data during the first minute of monitoring, before the monitor has recorded a snapshot or generated a trend, the monitor might display the message, "File transfer failure". If this occurs, cancel the AutoPrint operation and continue monitoring.

Note The following message might appear when AutoPrint starts:
"To help protect your computer, Windows Firewall has blocked some features of this program. Do you want to keep blocking this program?"
To prevent this message from appearing again, select **Unblock**.

Note AutoPrint works only when the monitor is powered on. This feature helps you be certain that only the data for the current patient is being printed or, if no patient is being monitored, that only the data for the last patient monitored is being printed.

Note If the monitor is off when it is placed in the cradle, AutoPrint is disabled. To enable AutoPrint, turn the monitor on and select **Continue Patient**.

Note If you turn the monitor on and select **Start New Patient**, all stored patient data is deleted from the monitor and cannot be printed.

The printed data includes the following:

In the Trends printout:

- Up to 24 hours of HR/PR, RR/BR, and SpO₂ trends (one set of measurements per row, with a 15-minute interval between rows).
- SpO₂ spot checks and NIBP measurements, interspersed among the rows of trends data.

In the Snapshots printout:

- Up to twenty snapshots (21-second intervals of full-disclosure patient data, including waveforms and numerics).
- The utility extracts the available ECG Leads from the patient data and prints a page of strips for each snapshot. Depending on the number of ECG Leads available, the strips may contain 21 seconds of data for one or three Leads of ECG data.

The utility supports US Letter and European A4 page sizes.

Printing

To print the patient data stored in a monitor

1. Install the AutoPrint Utility on a PC.
 - a. Insert the Propaq LT Monitor PC Utility Program in the CD-ROM drive of the PC.
 - b. Follow the on-screen instructions to install the AutoPrint Utility.
2. Connect the PC to a cradle (Propaq LT Monitor Charging/Communications Cradle), using the supplied USB cable.

Each time a monitor is inserted into this cradle while the cradle is connected via USB cable to the PC, the patient data stored in the monitor is printed on the default printer.

Patients monitored continuously for 24 hours typically generate enough data for a 2- or 3-page trends table of two panels per page. For example, a 24-hour report with the following data (192 rows) would cover three pages:

- 96 rows of vital-signs data (4 intervals/hr = 4 rows per hour) for 24 hours
- 48 NIBP readings (2/hr)
- 48 SpO₂ spot-check readings (2/hr)

Figure 100 shows a typical printout.

- Text in italic font indicates one of the trends measurements taken at 15-minute intervals.
- Text in bold font indicates an NIBP measurement or an SpO₂ spot check.
- White text in a black box indicates an alarm condition—a measurement that is outside of alarm limits.
 - indicates a measurement value below the monitor's measurement range.
 - +++ indicates a measurement value above the monitor's measurement range.
 - ??? indicates an undetermined measurement value.

Note For monitors equipped with Masimo SpO2 technology, the printout includes Perfusion Index readings.

Figure 100. Printout (trends page)

Monday, June 20, 2005 09:23:28					WelchAllyn®	
HALL, ROBERT E.			3456187	239	1 of 1	
Name			Patient ID #	Location	Page	
09:23		Tabular Trend Adult			11:51	
Time	HR/PR	RR/BR	SpO2	NIBP		
HH:MM	BPM	Br/M	%	mmHg		
09:30	65	14	OFF	OFF		
09:45	72	15	OFF	OFF		
10:00	67	15	OFF	OFF		
10:15	72	16	OFF	OFF		
10:30	71	15	OFF	OFF		
10:45	79	16	OFF	OFF		
11:00	73	16	OFF	OFF		
11:15	66	14	OFF	OFF		
11:30	67	15	OFF	OFF		
11:31	79	OFF	OFF	131 / 88 (99)		
11:32	71	OFF	OFF	117 / 80 (91)		
11:32	71	OFF	OFF	124 / 86 (97)		
11:33	67	OFF	OFF	126 / 82 (95)		
11:34	71	OFF	OFF	125 / 84 (95)		
11:34	75	OFF	OFF	117 / 80 (90)		
11:35	66	OFF	OFF	118 / 82 (93)		
11:36	67	OFF	OFF	119 / 82 (92)		
11:37	63	OFF	OFF	125 / 83 (94)		
11:41	67	OFF	86	OFF		
11:43	69	OFF	96	OFF		
11:44	72	OFF	98	132 / 88 (101)		
11:45	69	OFF	OFF	OFF		

Trend rows at 15-minute intervals

NIBP measurements without SpO₂

SpO₂ spot check- alarm condition

SpO₂ spot check - normal

NIBP measurement with SpO₂

Final trend row

Figure 101. Printout (snapshots page)

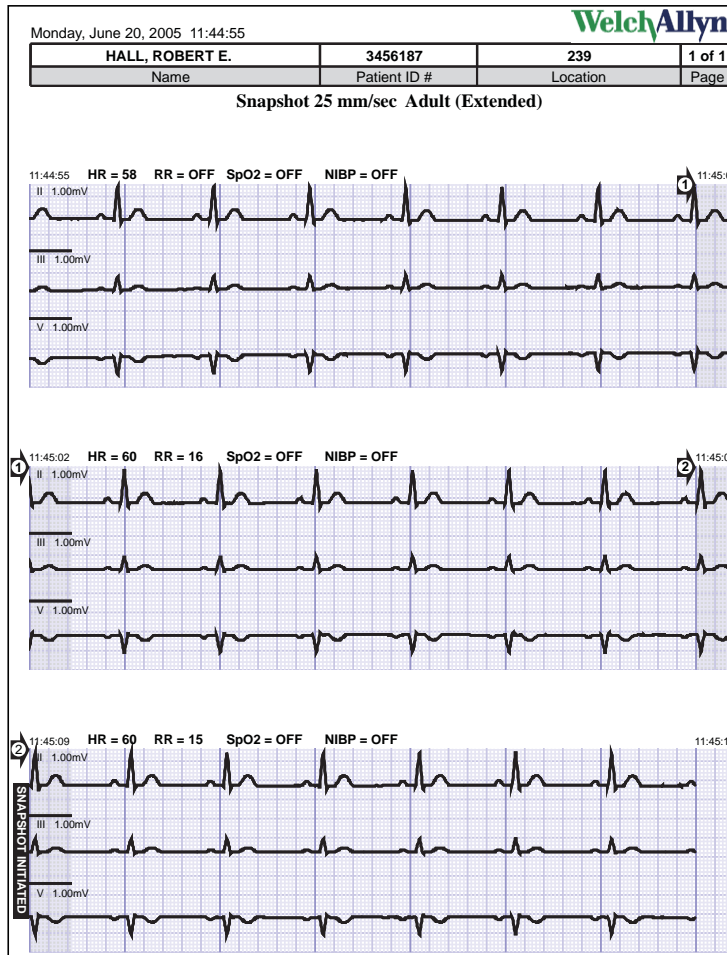

AutoPrint options

Enable/disable AutoPrint

To enable or disable the AutoPrint function

1. Start -> All Programs -> Welch Allyn -> Propaq LT Monitor -> AutoPrint On-Off

Figure 102. AutoPrint On/Off

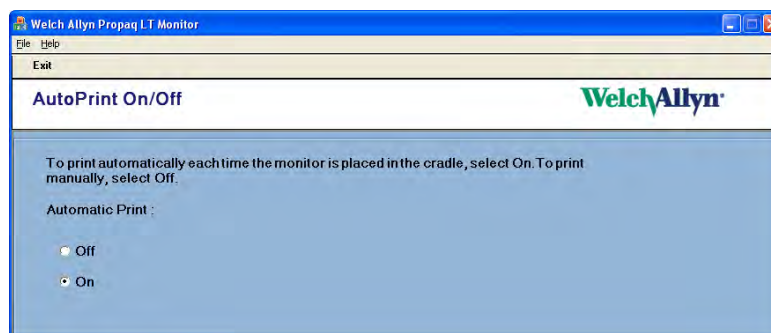

2. Click **On** or **Off**.

You can use the AutoPrint Utility to print automatically (the default function) or manually.

Printing manually

To print manually

1. **Start -> All Programs -> Welch Allyn -> Propaq LT Monitor -> AutoPrint On-Off**
2. Click **Off**.
3. **Start -> All Programs -> Welch Allyn -> Propaq LT Monitor -> Print Snapshots and Trends**

Canceling a print request

When the utility receives a print request, it immediately uploads patient data from the monitor to the PC and presents a print dialog. You have 10 seconds to cancel the print request (which automatically exits the AutoPrint Utility). If you do not cancel, the utility prints the patient data.

When uploading is complete

When the data has been uploaded and sent to the printer, the utility presents the options to reprint the current data, print the data from another monitor, or exit the utility.

If you select to reprint, the data is printed again.

If you select to print data from another monitor, the utility prompts you to replace the monitor in the cradle with another monitor.

Note All patient data is deleted from the PC when it is sent to the printer. If you insert another monitor and upload the data from it, the data from the previous upload is lost.

If you select to exit, the utility exits.

If you do nothing for one minute after the data is uploaded to the PC, the utility exits.

Creating a PDF of patient data

This procedure requires a PC connected to a monitor and cradle via a USB cable. The Welch Allyn AutoPrint Utility must be installed on the PC, but not running. The cradle must include the USB data transfer option.

To create a PDF of patient data

1. On the PC, install a PDF writer tool.

Many PDF writer tools are available. For example, you can find PDF writer tools at the following web locations:

- www.pdf995.com
- www.cutepdf.com

- www.adobe.com

Welch Allyn does not recommend one PDF writer tool over another.

2. On the PC, change the default printer to the newly installed PDF writer, as follows:
 - a. Open the **Control Panel**.
 - b. Double-click **Printers and Faxes**.



- c. In the **Printer and Faxes** dialog, right-click on the newly installed PDF writer and check **Set as Default**.
3. On the PC, start the AutoPrint Utility:

Start > Programs > Welch Allyn > Propaq LT AutoPrint Utility

The AutoPrint Utility immediately begins transferring data files from the monitor to the PC.

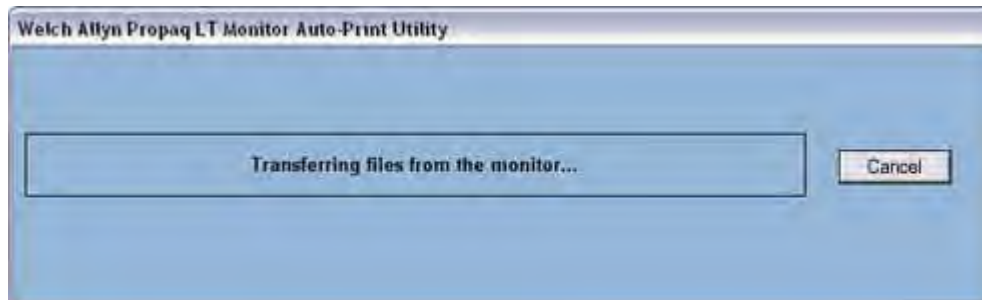

4. Save the data as a single PDF file containing all of the snapshots and trends.

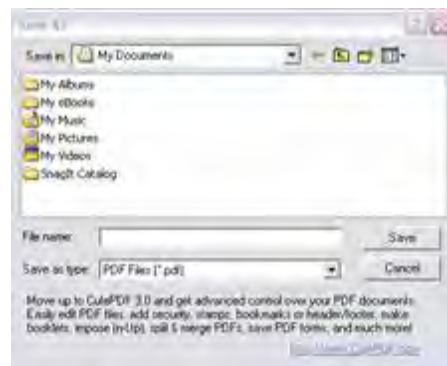

This saved PDF file can now be printed, emailed, or viewed on-screen.

8

Monitor configuration

Overview

The monitor can be configured in various ways.

Each facility can define as many **default configurations** as required to both meet the needs of individual departments and units and to conform to the facility's general methods and standards.

- Each time the patient mode is changed, the monitor settings return to the default configuration settings for that patient mode.
- Each time the monitor is turned on, the clinician chooses either to retain the most recently used temporary, patient-specific settings or to reset the monitor to its default configuration.

Clinicians can use the monitor buttons to **customize settings** to meet the needs of individual patients. These custom settings can be

- discarded when the monitor is turned off and then restarted.
- retained when the monitor is turned off and then restarted.
- saved as the new default configuration for the monitor.

Note If you change **alarm limits** while monitoring a patient, you can make these changes either temporary or permanent. See [“Changing alarm limits”](#) on page 84.

When a wireless monitor is in communication with an Acuity Central Station, **Acuity imposes several monitor settings** to assure conformance and consistency among all monitors on a network. These settings override the factory configuration, the default configuration, and any temporary patient-specific settings. If the monitor power is cycled while the monitor is no longer in communication with Acuity, the monitor powers up with the default configuration or with the custom settings for the previously monitored patient.

About factory configuration

When the monitor arrives from the factory, it is fully configured and ready for operation. The **factory configuration** defines every setting and behavior for the monitor. Each setting and behavior defined in the factory configuration remains in effect until it is changed by a custom configuration or by a temporary adjustment. Unless the factory configuration is replaced by a custom configuration, the factory settings and behaviors are restored to the monitor each time the monitor is powered up and **Start New Patient** is selected.

When a custom configuration is downloaded to the monitor, the settings and behaviors defined in the custom configuration become the power-up defaults for the monitor, and the factory configuration is no longer in effect. However, the factory configuration information can always be restored by qualified service personnel and can also be restored by downloading the configuration file *PropaqLTFactoryConfig.mnt* from a PC to the monitor.

The factory settings are shown in the [“Parameter configuration matrix”](#) on page 105.

About default configuration

Most facilities, before putting a new monitor into service, reconfigure it to conform to local protocol and to adapt it to the clinical environment in which it is to be used. This reconfiguration results in a set of default settings and monitor behaviors.

Creating a custom default configuration requires the following:

- A Propaq LT Monitor Configuration Utility running on a PC, and
- A cradle with the USB data transfer option

For information about the monitor Configuration Utility, refer to [“Using the Configuration Utility to configure the monitor”](#) on page 116.

To learn which parameters can be defined using the Configuration Utility, see the [“Parameter configuration matrix”](#) on page 105.

About temporary configuration

While monitoring a patient, you can use the monitor buttons to temporarily adjust many of the monitor settings to accommodate the needs of a specific patient. These custom settings persist through a power cycle if you select to save patient data on shut-down. They persist until they are changed manually or by Acuity, or until the monitor is powered down and then powered up to monitor another patient.

Note If you change **alarm limits** while monitoring a patient, you can make these changes either temporary or permanent. For complete information, see [“Changing alarm limits”](#) on page 84.

To learn which parameters can be temporarily defined using the user interface, see the [“Parameter configuration matrix”](#) on page 105.

About Acuity-defined configuration

When the monitor comes into communication with the Acuity Central Station, Acuity downloads some parameter values to the monitor.

The Acuity-defined configuration persists until the monitor is powered off.

To learn which parameters are defined by Acuity, see [“Parameter configuration matrix”](#) on page 105.

Parameter configuration matrix

This table lists the factory settings and the possible values for all parameters, and indicates which parameters and settings can be defined by Acuity, through the Configuration Utility, or by the clinician through the monitor buttons.

Note This table shows only those parameters that can be changed.

Note Except for **Radio ESSID (NetName)** and **Can Disable HR/PR Alarm Limits**, this table does not show parameters intended for use only by qualified service personnel.

Table 10. Parameter configuration matrix

Parameter	Factory setting	Possible values	Where set
General			
Patient Name (Last, First, MI)	[blank]	(≤16 characters displayed; actual number of characters depends on character width)	Monitor, Acuity
Patient ID	[blank]	(12 or 16 characters)	Acuity
Room	[blank]	(5 characters)	Monitor, Acuity
Regulatory Setting	US	US, European EC, Japan Metrology	Configuration Utility, Acuity
Patient Mode	Adult	Adult, Pediatric, Neonate	Monitor, Configuration Utility, Acuity
LCD Bias	13	1 - 64	Monitor
Network			
Radio Card ON and Acuity Enabled	YES if the radio card is installed. NO if the radio card is not installed.	Yes, No	Configuration Utility
Radio ESSID (NetName)	com.protocol	com.protocol, demo.protocol com1.protocol, com2.protocol com3.protocol, com4.protocol com5.protocol, com6.protocol com7.protocol, com8.protocol com9.protocol, com10.protocol com11.protocol, com12.protocol com13.protocol, com14.protocol com15.protocol, com16.protocol com17.protocol, com18.protocol	Monitor
Radio disconnect	Not disconnected	Disconnected, not disconnected	Monitor
User interface			
Configuration Name	Factory 1.30	0 - 40 characters	Configuration Utility
Facility Name	[blank]	0 - 40 characters	Configuration Utility
Contact Name	[blank]	0 - 40 characters	Configuration Utility
Unit/Department ID	[blank]	0 - 40 characters	Configuration Utility
Contact Telephone	[blank]	0 - 40 characters	Configuration Utility

Table 10. Parameter configuration matrix (continued)

Parameter	Factory setting	Possible values	Where set
Time Format	24-Hr	12-Hr, 24-Hr	Monitor, Configuration Utility
Configured Language	English	Dutch, English, French, German, Italian, Polish, Portuguese, Spanish, Swedish	Monitor, Acuity, Configuration Utility
Decimal Format	Dot	Comma, Dot	Configuration Utility
Date Format	MM/DD/YY	MM/DD/YY, DD.MM.YY, YY/MM/DD	Monitor, Configuration Utility
Alarm/Alert Tone Level	Medium	Low, Medium, High	Monitor, Configuration Utility, Acuity
HR/Pulse Tone Level	Medium	Off, Low, Medium, High	Monitor, Configuration Utility
NIBP Units	mmHg	mmHg, kPa	Monitor, Configuration Utility
Audible Alarm Suspension Time	2 min	Disable, 90 sec, 2 min, 3 min, 4 min, 5 min, 10 min, 15 min, 30 min, 60 min, Always On	Monitor, Configuration Utility
Pacer Indicator On	No	Yes, No	Monitor, Configuration Utility
Buttons Lock-Out Enabled	Yes	Yes, No	Configuration Utility, Acuity
Display Lock-Out Enabled	Yes	Yes, No	Configuration Utility
Back Light Lock-Out Enabled	Yes	Yes, No	Configuration Utility
Back Light Time-Out	2 min	Always Off, 2 min, 5 min, 10 min, 15 min, 30 min, Always On	Monitor, Configuration Utility
Display Time-Out	Always On	2 min, 5 min, 10 min, 15 min, 30 min, Always On	Monitor, Configuration Utility
Adult NIBP Mean Numerics	Small	Small, Large, Off	Monitor, Configuration Utility
Pediatric NIBP Mean Numerics	Small	Small, Large, Off	Monitor, Configuration Utility
Neonatal NIBP Mean Numerics	Large	Small, Large, Off	Monitor, Configuration Utility
Display All ECG Vectors	Yes	Yes, No	Configuration Utility
ECG I Wave Size	1 mV/cm	8 mV/cm, 4 mV/cm, 2 mV/cm, 1 mV/cm, 0.5 mV/cm, 0.2 mV/cm	Monitor
ECG II Wave Size	1 mV/cm	8 mV/cm, 4 mV/cm, 2 mV/cm, 1 mV/cm, 0.5 mV/cm, 0.2 mV/cm	Monitor
ECG III Wave Size	1 mV/cm	8 mV/cm, 4 mV/cm, 2 mV/cm, 1 mV/cm, 0.5 mV/cm, 0.2 mV/cm	Monitor
ECG V Wave Size	1 mV/cm	8 mV/cm, 4 mV/cm, 2 mV/cm, 1 mV/cm, 0.5 mV/cm, 0.2 mV/cm	Monitor
ECG aVR Wave Size	1 mV/cm	8 mV/cm, 4 mV/cm, 2 mV/cm, 1 mV/cm, 0.5 mV/cm, 0.2 mV/cm	Monitor
ECG aVL Wave Size	1 mV/cm	8 mV/cm, 4 mV/cm, 2 mV/cm, 1 mV/cm, 0.5 mV/cm, 0.2 mV/cm	Monitor

Table 10. Parameter configuration matrix (continued)

Parameter	Factory setting	Possible values	Where set
ECG aVF Wave Size	1 mV/cm	8 mV/cm, 4 mV/cm, 2 mV/cm, 1 mV/cm, 0.5 mV/cm, 0.2 mV/cm	Monitor
SpO ₂ Wave Size	2x	1x, 2x, 4x, 8x	Monitor
Resp Wave Size	2x	0.5x, 1x, 2x, 4x, 8x, 16x	Monitor
ParamSet Enable	Yes	Yes, No	Configuration Utility
NIBP Turbo Mode Enable	Yes	Yes, No	Configuration Utility
Tab Trend Display Interval	5 min	1 min, 5 min, 10 min, 15 min, 30 min, 60 min	Monitor, Configuration Utility
Current screen	Display 1	Display 1, Display 2, Display 3	Monitor
Sensitivity (Masimo)	Enabled	Enabled, Disabled	Configuration Utility
Sensitivity (Masimo)	Normal	Normal, Maximum, APOD	Monitor, Configuration Utility
FastSAT (Masimo)	Enabled	Enabled, Disabled	Configuration Utility
FastSAT (Masimo)	Off	Off, On	Monitor, Configuration Utility
Averaging Time (Masimo)	Enabled	Enabled, Disabled	Configuration Utility
Averaging Time (Masimo)	8	2, 4, 8, 10, 12, 14, 16 (seconds)	Monitor, Configuration Utility
Display 1			
Format	Large numerics	Large Numerics, Single Waveform, Dual Waveform, Tabular Trends, Tabular Trends with Waveform	Monitor, Configuration Utility
Top Waveform (if any)	Lead II	Lead I, Lead II, Lead III, Lead V, aVR, aVL, aVF, SpO ₂ , Resp	Monitor, Configuration Utility
Show Top Waveform 6 Seconds	No	Yes, No	Monitor, Configuration Utility
Show Bottom Waveform 6 Seconds	No	Yes, No	Monitor
Bottom Waveform (if any)	Lead V	Lead I, Lead II, Lead III, Lead V, aVR, aVL, aVF, SpO ₂ , Resp	Monitor, Configuration Utility
Tabular Trends Display Interval	5 min	1 min, 5 min, 10 min, 15 min, 30 min, 60 min	Monitor, Configuration Utility

Table 10. Parameter configuration matrix (continued)

Parameter	Factory setting	Possible values	Where set
Display 2			
Format	Single waveform	Large Numerics, Single Waveform, Dual Waveform, Tabular Trends, Tabular Trends with Waveform	Monitor, Configuration Utility
Top Waveform (if any)	Lead II	Lead I, Lead II, Lead III, Lead V, aVR, aVL, aVF, SpO ₂ , Resp	Monitor, Configuration Utility
Show Top Waveform 6 Seconds	No	Yes, No	Monitor, Configuration Utility
Show Bottom Waveform 6 Seconds	No	Yes, No	Monitor
Bottom Waveform (if any)	Lead V	Lead I, Lead II, Lead III, Lead V, aVR, aVL, aVF, SpO ₂ , Resp	Monitor, Configuration Utility
Tabular Trends Display Interval	5 min	1 min, 5 min, 10 min, 15 min, 30 min, 60 min	Monitor, Configuration Utility
Display 3			
Format	Tabular trends with waveform	Large Numerics, Single Waveform, Dual Waveform, Tabular Trends, Tabular Trends with Waveform	Monitor, Configuration Utility
Top Waveform (if any)	Lead II	Lead I, Lead II, Lead III, Lead V, aVR, aVL, aVF, SpO ₂ , Resp	Monitor, Configuration Utility
Show Top Waveform 6 Seconds	No	Yes, No	Monitor, Configuration Utility
Show Bottom Waveform 6 Seconds	No	Yes, No	Monitor
Bottom Waveform (if any)	SpO ₂	Lead I, Lead II, Lead III, Lead V, aVR, aVL, aVF, SpO ₂ , Resp	Monitor, Configuration Utility
Tabular Trends Display Interval	5 min	1 min, 5 min, 10 min, 15 min, 30 min, 60 min	Monitor, Configuration Utility
EKG			
EKG Bandwidth	Monitor	Monitor, Extended	Monitor, Configuration Utility, Acuity
HR/PR general			
		If the monitor language is French, please see the note under “Selecting a language” on page 14.	
HR/PR Selected Source	EKG	EKG, SpO ₂	Monitor, Acuity
Can Disable HR/PR Alarm Limits	Yes (No if lang=French)	Yes, No	Monitor
Power Source Filter	60 Hz	50 Hz, 60 Hz, Off	Monitor, Configuration Utility, Acuity
ParamSet for Upper HR/PR Limit	20%	5% - 25%	Configuration Utility
ParamSet for Lower HR/PR Limit	20%	5% - 25%	Configuration Utility

Table 10. Parameter configuration matrix (continued)

Parameter	Factory setting	Possible values	Where set
HR/PR adult			
Upper Alarm Limit	120 beats/min	27 - 300 beats/min	Monitor
Lower Alarm Limit	50 beats/min	25 - 298 beats/min	Monitor
HR/PR pediatric			
Upper Alarm Limit	150 beats/min	27 - 300 beats/min	Monitor
Lower Alarm Limit	50 beats/min	25 - 298 beats/min	Monitor
HR/PR neonate			
Upper Alarm Limit	200 beats/min	27 - 300 beats/min	Monitor
Lower Alarm Limit	100 beats/min	25 - 298 beats/min	Monitor
NIBP general			
ParamSet for Upper NIBP Systolic	15%	5% - 25%	Configuration Utility
ParamSet for Lower NIBP Systolic	15%	5% - 25%	Configuration Utility
ParamSet for Upper NIBP Diastolic	15%	5% - 25%	Configuration Utility
ParamSet for Lower NIBP Diastolic	15%	5% - 25%	Configuration Utility
ParamSet for Upper NIBP Mean	10%	5% - 15%	Configuration Utility
ParamSet for Lower NIBP Mean	10%	5% - 15%	Configuration Utility
NIBP adult			
Auto Interval (minutes)	15	1, 2, 3, 5, 10, 15, 30, 60	Monitor, Configuration Utility
Mode	Manual	Manual, Auto	Monitor, Acuity
Smartcuf	Off	On, Off	Monitor, Acuity, Configuration Utility
Systolic Upper Alarm Limit	220 mmHg 29.3 kPa	32 - 260 mmHg 4.3 - 34.7 kPa	Monitor, Acuity
Systolic Lower Alarm Limit	75 mmHg 10.0 kPa	30 - 258 mmHg 4.0 - 34.4 kPa	Monitor, Acuity
Diastolic Upper Alarm Limit	110 mmHg 14.7 kPa	22 - 235 mmHg 2.9 - 31.3 kPa	Monitor, Acuity
Diastolic Lower Alarm Limit	35 mmHg 4.7 kPa	20 - 233 mmHg 2.7 - 31.1 kPa	Monitor, Acuity
Mean Upper Alarm Limit	120 mmHg 16.0 kPa	22 - 255 mmHg 2.9 - 34.0 kPa	Monitor, Acuity
Mean Lower Alarm Limit	50 mmHg 6.7 kPa	20 - 253 mmHg 2.7 - 33.7 kPa	Monitor, Acuity

Table 10. Parameter configuration matrix (continued)

Parameter	Factory setting	Possible values	Where set
NIBP pediatric			
Auto Interval (minutes)	15	1, 2, 3, 5, 10, 15, 30, 60	Monitor, Configuration Utility
Mode	Manual	Manual, Auto	Monitor, Acuity
Smartcuf	Off	On, Off	Monitor, Acuity, Configuration Utility
Systolic Upper Alarm Limit	145 mmHg 19.3 kPa	32 - 160 mmHg 4.3 - 21.3 kPa	Monitor, Acuity
Systolic Lower Alarm Limit	75 mmHg 10.0 kPa	30 - 158 mmHg 4.0 - 21.1 kPa	Monitor, Acuity
Diastolic Upper Alarm Limit	100 mmHg 13.3 kPa	17 - 130 mmHg 2.3 - 17.3 kPa	Monitor, Acuity
Diastolic Lower Alarm Limit	35 mmHg 4.7 kPa	15 - 128 mmHg 2.0 - 17.1 kPa	Monitor, Acuity
Mean Upper Alarm Limit	110 mmHg 14.7 kPa	17 - 140 mmHg 2.3 - 18.7 kPa	Monitor, Acuity
Mean Lower Alarm Limit	50 mmHg 6.7 kPa	15 - 138 mmHg 2.0 - 18.4 kPa	Monitor, Acuity
NIBP neonatal			
Auto Mode Interval (minutes)	15	1, 2, 3, 5, 10, 15, 30, 60	Monitor, Configuration Utility
Mode	Manual	Manual, Auto	Monitor, Acuity
Smartcuf	Off	On, Off	Monitor, Acuity, Configuration Utility
Systolic Upper Alarm Limit	100 mmHg 13.3 kPa	27 - 120 mmHg 3.6 - 16.0 kPa	Monitor, Acuity
Systolic Lower Alarm Limit	50 mmHg 6.7 kPa	25 - 118 mmHg 3.33 - 15.7 kPa	Monitor, Acuity
Diastolic Upper Alarm Limit	70 mmHg 9.3 kPa	12 - 105 mmHg 1.6 - 14.0 kPa	Monitor, Acuity
Diastolic Lower Alarm Limit	30 mmHg 4.0 kPa	10 - 103 mmHg 1.3 - 13.7 kPa	Monitor, Acuity
Mean Upper Alarm Limit	80 mmHg 10.7 kPa	12 - 110 mmHg 1.6 - 14.7 kPa	Monitor, Acuity
Mean Lower Alarm Limit	35 mmHg 4.7 kPa	10 - 108 mmHg 1.3 - 14.4 kPa	Monitor, Acuity
SpO₂ general			
Enable Spot Checks	Yes	Yes, No	Configuration Utility
ParamSet for Upper SpO ₂	5%	5% - 10%	Configuration Utility
ParamSet for Lower SpO ₂	5%	5% - 10%	Configuration Utility
SpO₂ adult			
Upper Alarm Limit	100%	52% - 100%	Monitor, Acuity
Lower Alarm Limit	90%	50% - 98%	Monitor, Acuity

Table 10. Parameter configuration matrix (continued)

Parameter	Factory setting	Possible values	Where set
SpO₂ pediatric			
Upper Alarm Limit	100%	52% - 100%	Monitor, Acuity
Lower Alarm Limit	90%	50% - 98%	Monitor, Acuity
SpO₂ neonatal			
Upper Alarm Limit	95%	52% - 100%	Monitor, Acuity
Lower Alarm Limit	85%	50% - 98%	Monitor, Acuity
SpO₂ Masimo			
Perfusion Index	Enabled	Enabled, Not enabled	Configuration Utility
Signal IQ	Enabled	Enabled, Not enabled	Configuration Utility
Resp general			
ParamSet for Upper Resp	5%	5% - 25%	Configuration Utility
ParamSet for Lower Resp	5%	5% - 25%	Configuration Utility
Resp adult			
Resp On/Off	No	Yes, No	Monitor, Configuration Utility
Vector	Ld1	Ld1 (RA-LA), Ld2 (RA-LL)	Monitor, Configuration Utility, Acuity
Upper Alarm Limit	30/min	4/min - 150/min	Monitor, Acuity
Lower Alarm Limit	5/min	2/min - 148/min	Monitor, Acuity
Resp pediatric			
Resp On/Off	Yes	Yes, No	Monitor, Configuration Utility
Vector	Ld1	Ld1 (RA-LA), Ld2 (RA-LL)	Monitor, Configuration Utility, Acuity
Upper Alarm Limit	45/min	4/min - 150/min	Monitor, Acuity
Lower Alarm Limit	10/min	2/min - 148/min	Monitor, Acuity
Resp neonatal			
Resp On/Off	Yes	Yes, No	Monitor, Configuration Utility
Vector	Ld1	Ld1 (RA-LA), Ld2 (RA-LL)	Monitor, Configuration Utility, Acuity
Upper Alarm Limit	60/min	5/min - 150/min	Monitor, Acuity
Lower Alarm Limit	10/min	3/min - 148/min	Monitor, Acuity

9

PC utility

Introduction

Use the Propaq LT Monitor PC utility to install either or both of the following utilities on a PC:

- Propaq LT Monitor Configuration utility
- Propaq LT Monitor AutoPrint utility

These utilities can then be used to control the behavior of any Propaq LT monitor.

Propaq LT Monitor Configuration utility

The monitor comes fully configured and ready for operation. If the factory configuration does not match your specific needs, you can use the Propaq LT Monitor Configuration utility to customize the monitor to fit the requirements of your clinical situation.

To configure the monitor

1. Use the configuration worksheet to specify the monitor settings. (See [“Configuration worksheet”](#) on page 123.)
2. On a PC running the Propaq LT Monitor Configuration utility, enter the settings into a configuration file. (See [“Creating a configuration file”](#) on page 116.)
3. On a PC connected to a Propaq LT Monitor charging/communications cradle configured with the optional data link capability, download the configuration file to any number of Propaq LT monitors. (See [“Configuring a monitor”](#) on page 117.)

Propaq LT Monitor AutoPrint Utility

With a PC connected to a printer and with a cradle configured with the optional data link capability, you can configure the PC to print, manually or automatically, all patient data stored in the monitor each time the monitor is placed in the cradle. (See [“Printing patient data”](#) on page 97.)

Installation

System requirements

PC on which you have administrator privileges

CPU	800 MHz or faster
Hard drive	20 GB or more
CD ROM drive	
Available RAM	256 MB or more
Available Port	USB 1.1
OS	Windows 2000 or Windows XP

Printer installed and configured

Resolution	300 dpi minimum; 600 dpi or higher recommended
------------	------------------------------------------------

Propaq LT Monitor PC Utility software (CD)

Procedure

Launching the installation

1. Insert the software distribution CD in a CD-ROM drive of your PC.
2. When the installation program starts, follow the instructions presented on your computer monitor.

If you are installing on a PC running Windows XP, you might see the message shown below. Click **Continue Anyway** to continue the installation.

Figure 103. Windows logo message



Usually, the installation completes quickly. However, if the utility also has to install .NET Framework on your computer, this can add several minutes.

3. Click through the Welcome screen and the license agreement.
You must accept the terms of the license agreement to proceed with the installation.

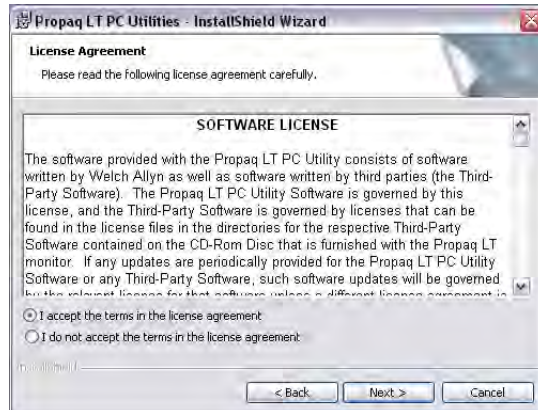
Figure 104. Accepting the terms of the software license

4. Determine whether you want to install the Configuration utility only, the AutoPrint utility only, or both utilities.

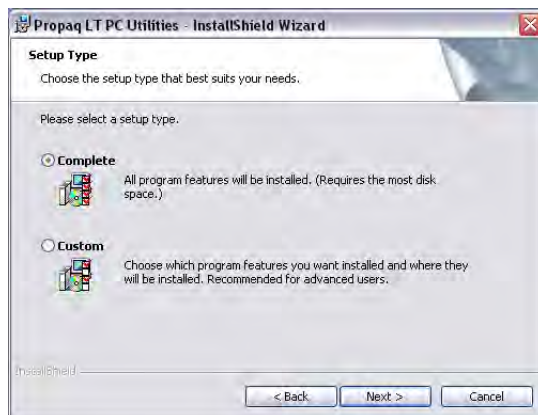
Figure 105. Complete or Custom installation

- To install both utilities, click **Complete**.
- To install only one of the utilities, click **Custom** and, in the next screen, select the utility you want to install.

Figure 106. Selecting to install either the AutoPrint utility or the Configuration utility

If you click the drop-down menu next to your choice, you can also select one of the installation options available for that choice.

Figure 107. Menu of installation options

5. The installation prompts you occasionally for information. At each prompt, provide the requested information and then click **Next**. The installation continues until it is finished.

Using the Configuration Utility to configure the monitor

Creating a configuration file

1. Start the Configuration utility.
Double-click the **Configuration** icon.



The Welcome screen appears.

2. Do one of the following:
 - Select a file from the displayed list, click **Select**, and then **File > Save As**.
 - **File > New, File > Save As**.



If the PC contains no configuration files, the Identification page of the default configuration soon appears. Save this configuration as a new file (**File > Save As**).

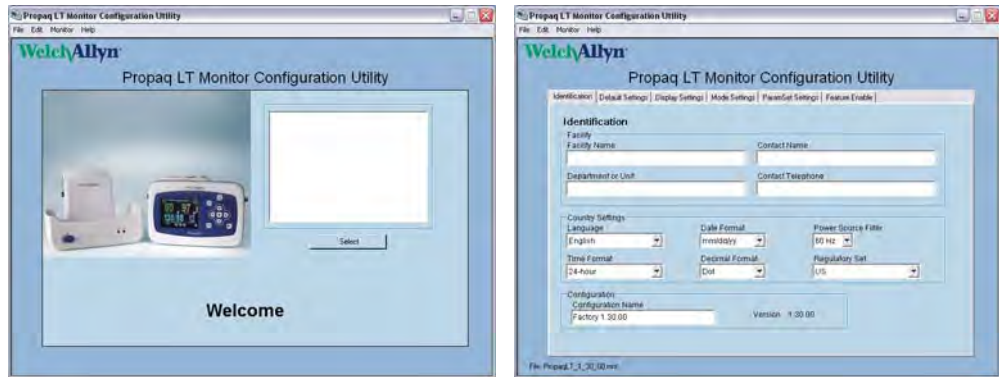

Modifying a configuration file

To modify a configuration file

1. Open the file.
2. Modify the settings.
3. Save the file.

Configuring a monitor

See “[System requirements](#)” on page 114.

To configure a monitor

1. Connect the PC to a cradle, using the supplied USB cable.
2. Seat the monitor in the cradle.
3. If the monitor is off, turn it on and select **Start New Patient**.
4. Start the utility.
5. Select the configuration file that you want to upload.
6. Click **Monitor > Send**.
7. Wait a few seconds. When the upload is complete, a completion message appears and then the monitor shuts off.
8. Remove the monitor from the cradle. It is now configured.

Note To receive the configuration file from the monitor, click **Monitor > Receive**.

Configuration settings

Configuration pages

Figure 108. Configuration file display: Identification page

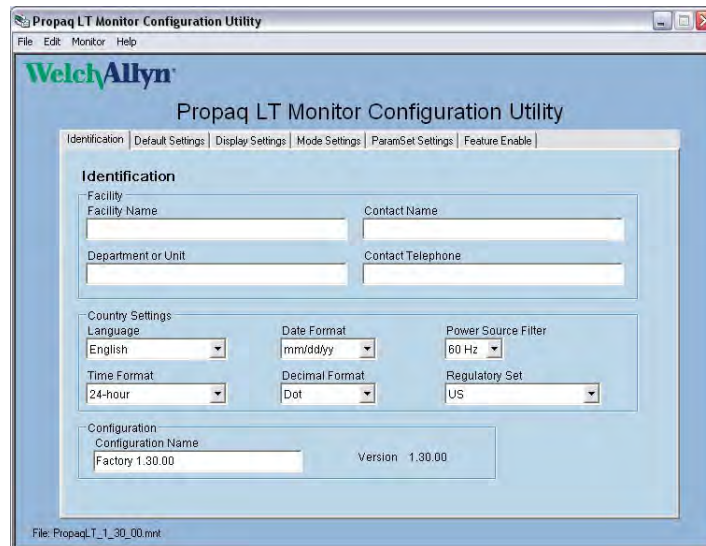

Click the page tabs (**Identification**, **Default Settings**, **Display Settings**, **Mode Settings**, **ParamSet**, and **Feature Enable**) to navigate to the settings of interest.

Identification	Name the configuration, define monitor ownership and support responsibility, and define parameters related to your locale. Each string is limited to 40 characters.
Default Settings	Define the general properties of the monitor.
Display Settings	
Display 1	Define the appearance of Display 1.
Display 2	Define the appearance of Display 2.
Display 3	Define the appearance of Display 3.
Mode Settings	
Neonatal mode	Define default settings for neonatal patients.
Pediatric mode	Define default settings for pediatric patients.
Adult mode	Define default settings for adult patients.
ParamSet	Define the alarm-limit adjustment percentages (ParamSet) for systolic, diastolic, and mean pressures, HR/PR, SpO ₂ , and respiration rate.
Feature Enable	Specify the monitor features available to clinicians.

Configuration Utility command options

File	
New	The utility opens a new configuration file with all settings at the factory values. Change the settings as needed and save the file under a new name.
Open	Open a configuration file. You can modify it (Save), use it as the starting point for a new file (Save As), or close it (Exit).
Save	Save the changes to the open configuration file.
Save As	Save the open configuration file under a new name.
Print Preview	Access options for previewing and printing report pages.
Print	Print a report of configuration settings.
Exit	Close the configuration file.
Edit	
Cancel Edits	Cancel all changes made since the last 'Save'.
Monitor	
Receive	Upload the configuration file from the monitor to the PC. Note: The configuration file on the monitor does not necessarily reflect the current monitor configuration. Note: If the monitor is older than version 1.30.00, the Configuration Utility cannot receive the file. Note: If the monitor configuration file was created using a Configuration Utility older than version 1.30.00, some parameters are not defined. The 'Receive' function sets these parameters to the factory defaults.
Send	Configure the monitor by downloading the displayed configuration file.
Help	
Version Compatibility	Display information about downloading configuration files when the monitor and the Configuration Utility versions do not match.
About	Display the version of the Configuration Utility.

Error messages

These messages are displayed at the PC if communication or version problems arise between the Configuration Utility and the monitor.

Message

Communication with the monitor failed. Verify that the monitor is powered on and properly seated in the cradle. Verify that the cable is connected.

Could not read patient data from the monitor. Please contact Welch Allyn customer service.

Message

The configuration file did not install on the monitor. Verify all connections between monitor, cradle, and PC and try again. If problems continue, contact Welch Allyn customer service.

The configuration File: *[file name]* that you are attempting to read is in the wrong format. Please select another file. The configuration file was modified outside of the Configuration Utility.

Receive operation failed.
The Configuration Utility version is older than the monitor software version.
Configuration Utility upgrade recommended.

Receive operation failed.
The monitor software version is older than the Configuration Utility version.
Monitor software upgrade recommended.

About the configuration worksheet



WARNING You must read and understand the warning statements in “[Use Smartcuf as Default for NIBP](#)” on page 131 before any configuration file is created based on a worksheet.

The first step in customizing a monitor configuration is to complete a configuration worksheet. This defines the settings to be stored in the monitor.

Note A worksheet is not required. The worksheet makes it possible for key clinical staff to preview and approve the configuration, and it makes it easier to create the configuration file.

Print the worksheet ([page 123](#) to [page 138](#) of this document) and supply the values for any settings you want to change. When the worksheet is complete, give it to the person designated to create the new configuration file.

About defaults

The settings defined for the monitor when it first arrives from the factory are called ‘factory defaults’. Factory defaults include settings for most parameters and also define whether certain monitor features are enabled or disabled.

An example of a default setting:

The default volume of the alarm tone is **Medium**. To change the default volume level to Low, select **Low** in the configuration file. (Like many other monitor settings, the volume of the alarm tone can also be changed by the clinician while the monitor is in use. The configuration simply defines what the setting will be when the monitor power is turned on.)

An example of enabled and disabled features:

The monitor behavior **Pacer Indicator On Default** has a default value of **No**, so the monitor does not, by default, include pacemaker indicators in an ECG waveform display. To change the default behavior so that the monitor does show pacemaker indicators in an ECG waveform display, change the value to **Yes** in the custom configuration.

The feature Back Light Lockout Enable has a factory-default value of **Yes** (enabled), so it is, by default, available to clinicians. To make this feature unavailable to clinicians, change the value to **No** in the custom configuration.

Factory defaults remain in effect until you reconfigure the monitor by downloading a custom configuration file to it from the PC or until you replace them with the current settings.

After you reconfigure the monitor, the settings defined in the new configuration become the 'system defaults', and the factory defaults are no longer in effect.

The new system defaults remain in effect until one of the following occurs:

- another configuration is downloaded to the monitor
- you replace them with the current settings
- you restore the factory defaults

The monitor is reset to the current defaults every time the monitor power is cycled off and on, with one exception: If a clinician has changed some monitor settings at the bedside for a patient and then shuts off the monitor, the monitor offers the options to "Delete and Shut Down" and to "Save and Shut Down". If the clinician selects "Save and Shut Down," shuts off the monitor, and then turns on the monitor again, the monitor prompts with the choice, "Start New Patient" or "Continue Patient". If the clinician selects "Continue Patient," *the monitor uses the settings that were saved for that patient before the power was turned off*. If the clinician selects "Start New Patient," the system default settings are restored.

- In the configuration worksheet, the factory default values are indicated by **bold text**.
- In the Configuration Utility, the factory default values appear in the data fields when you open the default configuration file using the Configuration Utility. (File name: PropaqLT_SW_Version#.mnt; for example, PropaqLT_1_40_00.mnt.)



Caution Do not attempt to modify a configuration file without using the Propaq LT Configuration utility.

About AutoPrint

For information about using the AutoPrint Utility, see "[Printing patient data](#)" on page 97.

Configuration worksheet

Identification	124
Define monitor ownership and support responsibility, define parameters related to your locale, and name the configuration.	
Default Settings	126
Define the power-up settings for monitor behavior.	
Display Settings	128
Select and define the content of Display 1, Display 2, and Display 3.	
Mode Settings	131
Specify the default settings for Adult, Pediatric, and Neonatal patients.	
ParamSet Settings	133
Define the alarm-limit adjustment percentages (ParamSet) for systolic, diastolic, and mean pressures, HR/PR, SpO ₂ , and Resp.	
Feature Enable	135
Define the general properties of the monitor.	
Authorization	138
The final page of the worksheet identifies the person responsible for defining the custom configuration. The information on this page is not part of the monitor configuration.	
Note	For each parameter, the factory value is shown in bold . To specify a different value, circle, underscore, or enter another value.
Note	All required parameters are set at the factory. The monitor works even if you do not change any settings.

Identification

Facility

Facility Name

(Up to 40 characters.)

Contact Name

(Up to 40 characters.)

Department or Unit

(Up to 40 characters.)

Contact Telephone

(Up to 40 characters.)

Country Settings

Language

- English**
- Dutch
- French
- German
- Italian
- Polish
- Portuguese
- Spanish
- Swedish
- Japanese

Date Format

- mm/dd/yy**
- dd.mm.yy
- yy/mm/dd

Power Source Filter

- 60 Hz**
- 50 Hz
- Off

Set the power-source interference filter to the appropriate frequency for your location.

60 Hz **North America, Taiwan, and Japan**

50 Hz All other locations

Off

If the filter is not set, the ECG waveform displays might contain high-frequency noise caused by the interference generated from the facility ac power supply.

Time Format

- 12-hour AM/PM
 24-hour

Decimal Format

- Dot**
 Comma

You can configure the monitor to use a dot (for example, 195.18) or a comma (195,18) to display the decimal point.

Regulatory Set

- US**
 European EC
 Japan Metrology

Configuration

Configuration Name

Configuration Name
(Up to 40 characters.)

For each configuration, enter a unique name that identifies the following:

- the hospital and the care unit or department that owns the monitor
- the date on which this configuration is created

The name can include any standard keyboard characters other than the comma (,). For example:

StEGH #9 West Dec_29 2003

If multiple configuration files are created on the same day, include additional identifying information to the configuration name. For example:

StEGH #9 West Dec_29 2003 Pediatric

StEGH #9 West Dec_29 2003 Neonate

Default Settings

Default Selections

Patient Mode Default

- Adult**
- Pediatric
- Neonatal

Alarm Tone Level Default

- Low
- Medium**
- High

ECG Bandwidth Default

- Monitor**
- Extended

ECG Bandwidth refers to the frequency range used to display and print patient data.

- Monitor bandwidth is less susceptible to artifact such as patient motion.
- Extended bandwidth, although more susceptible to artifact, can provide for more detailed data analysis.

Monitor-Mode Bandwidth

Adult	0.5 Hz to 40 Hz
Pediatric/Neonate	0.5 Hz to 80 Hz

Extended-Mode Bandwidth

Adult	0.05 Hz to 40 Hz
Pediatric/Neonate	0.05 Hz to 80 Hz

HR/PR Tone Level Default

- Off
- Low
- Medium**
- High

Audible Alarms Suspension Time Default

- Disable (alarm tones cannot be suspended)
- 90 seconds
- 2 minutes**
- 3 minutes
- 4 minutes
- 5 minutes
- 10 minutes
- 15 minutes
- 30 minutes
- 60 minutes
- Always On (alarm tones always suspended)

While monitoring a patient, the clinician can use the settings menu to suspend all alarm tones for all parameters for a configurable period.

Note This parameter does not affect the behavior of $\frac{0}{\text{Silence/Reset}}$. Regardless of how this parameter is configured, pressing $\frac{0}{\text{Silence/Reset}}$ silences a sounding alarm tone for 90 seconds.

Suspend can be turned on or off by the clinician, but the suspend period cannot be changed by the clinician.

NIBP Units Default

- mmHg**
- kPa

Note If the monitor is connected to an Acuity Central Station, this is forced to **mmHg**.

Default Conditions

Pacer Indicator On Default

- (Yes)
- (No)**

If a patient being monitored has a pacemaker, the monitor detects the occurrence of pacemaker signals and optionally indicates them with vertical dashed lines in the waveform.

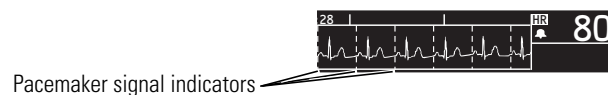



If the pacemaker signal is strong enough, the monitor displays it as a spike. This spike is displayed whether the pacemaker indicator is on or off.



Display All ECG Vectors

- (Yes)**
- (No)

Advancing Frontline Care™

Display Settings

The monitor interface includes a **Display** button: . Pressing  cycles the display quickly through the three views you specify below.

In the configuration, you can choose any three of the five display choices shown below for quick display with . For example, if you select **Large Numerics**, **Single Waveform**, and **Dual Waveform**, a clinician can repeatedly press  to see a patient's vital signs displayed first as large numerics, second as a single waveform with small numerics, and finally as a dual waveform with small numerics.

- You must include at least one display with a waveform.
- If you select **Single Waveform** and do not select **Dual Waveform**, **Tabular Trends**, or **Tabular Trends with Waveform**, users can still view dual waveforms, tabular trends, and tabular trends with a single waveform.
- If you do not select **Large Numerics**, clinicians cannot access the Large Numerics display.

After you select three displays (see "Display Format" on page 129), you can select the default appearance for each.

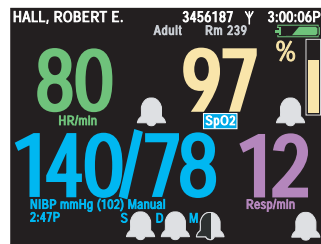

Large Numerics

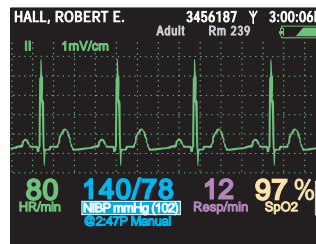

Single Waveform

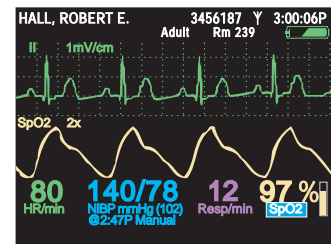

Dual Waveform

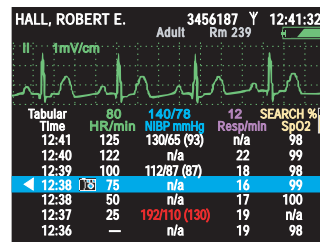

Tabular Trends with Waveform

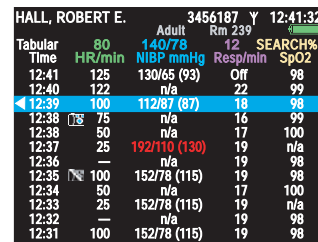

Tabular Trends

Display Format

Display 1

- Large Numerics**
- Single Waveform
- Dual Waveform
- Tabular Trends
- Tabular Trends with Waveform

Display 2

- Large Numerics
- Single Waveform**
- Dual Waveform
- Tabular Trends
- Tabular Trends with Waveform
- None

Display 3

- Large Numerics
- Single Waveform
- Dual Waveform
- Tabular Trends
- Tabular Trends with Waveform**
- None

Display 1

- Lead I
- Lead II**
- Lead III
- Lead V
- aVR
- aVL
- aVF
- SpO₂
- Resp

Display 2

- Lead I
- Lead II**
- Lead III
- Lead V
- aVR
- aVL
- aVF
- SpO₂
- Resp

Display 3

- Lead I
- Lead II
- Lead III
- Lead V
- aVR
- aVL
- aVF
- SpO₂**
- Resp

Enable the display of 6 seconds of the top waveform.

Display 1

- (Yes)
- (No)**

Display 2

- (Yes)
- (No)**

Display 3

- (Yes)
- (No)**

If you select (Yes), the monitor displays two consecutive 3-second periods of the top waveform.

If you select (No), the monitor displays 3 seconds of the top waveform and, if Dual Waveform is selected, 3 seconds of the bottom waveform.

Display Format (continued)

If Dual Waveform display is enabled, display this signal as the default lower waveform:

Display 1

- Lead I
- Lead II
- Lead III
- Lead V**
- aVR
- aVL
- aVF
- SpO₂
- Resp

Display 2

- Lead I
- Lead II
- Lead III
- Lead V**
- aVR
- aVL
- aVF
- SpO₂
- Resp

Display 3

- Lead I
- Lead II**
- Lead III
- Lead V
- aVR
- aVL
- aVF
- SpO₂
- Resp

If Tabular Trends display is enabled, this is the default data interval:

- 1 minute
- 5 minutes**
- 10 minutes
- 15 minutes
- 30 minutes
- 60 minutes

- 1 minute
- 5 minutes**
- 10 minutes
- 15 minutes
- 30 minutes
- 60 minutes

- 1 minute
- 5 minutes**
- 10 minutes
- 15 minutes
- 30 minutes
- 60 minutes

Mode Settings

Default Resp Lead

Adult	Pediatric	Neonatal
<input type="checkbox"/> Lead 1 (RA-LA)	<input type="checkbox"/> Lead 1 (RA-LA)	<input type="checkbox"/> Lead 1 (RA-LA)
<input type="checkbox"/> Lead 2 (RA-LL)	<input type="checkbox"/> Lead 2 (RA-LL)	<input type="checkbox"/> Lead 2 (RA-LL)

NIBP Mean Numerics

Adult	Pediatric	Neonatal
Small	Small	Small
Large	Large	Large
Off	Off	Off

Note Selecting **Large** reduces the size of the systolic and diastolic displays.

NIBP Mode

Adult	Pediatric	Neonatal
Auto, Manual	Auto, Manual	Auto, Manual

NIBP Auto Mode Interval

Adult (minutes)	Pediatric (minutes)	Neonatal (minutes)
1, 2, 3, 5, 10, 15 , 30, 60	1, 2, 3, 5, 10, 15 , 30, 60	1, 2, 3, 5, 10, 15 , 30, 60

Use Smartcuf as Default for NIBP

Adult	Pediatric	Neonatal
<input checked="" type="checkbox"/> (Yes)	<input checked="" type="checkbox"/> (Yes)	<input checked="" type="checkbox"/> (Yes)
<input type="checkbox"/> (No)	<input type="checkbox"/> (No)	<input type="checkbox"/> (No)

An NIBP measurement can be adversely affected by many factors, including body motion (such as convulsions or shivering), ambient vibration, vehicle motion, weak pulse, a sudden change in blood pressure, or sudden cuff movement. When these factors are present, Welch Allyn's patented Smartcuf technology can greatly increase the accuracy of NIBP measurements.

Note Smartcuf functions only during ECG monitoring.

Resp On Default

Adult	Pediatric	Neonatal
<input checked="" type="checkbox"/> (Yes)	<input checked="" type="checkbox"/> (Yes)	<input checked="" type="checkbox"/> (Yes)
<input type="checkbox"/> (No)	<input type="checkbox"/> (No)	<input type="checkbox"/> (No)

Alarm Limits

HR/PR

Adult			Pediatric			Neonatal		
Upper	On Off	120 ___	Upper	On Off	150 ___	Upper	On Off	200 ___
Lower	On Off	50 ___	Lower	On Off	50 ___	Lower	On Off	100 ___

Resp

Adult			Pediatric			Neonatal		
Upper	On Off	30 ___	Upper	On Off	45 ___	Upper	On Off	60 ___
Lower	On Off	5 ___	Lower	On Off	10 ___	Lower	On Off	10 ___

SpO₂

Adult			Pediatric			Neonatal		
Upper	On Off	100 ___	Upper	On Off	100 ___	Upper	On Off	95 ___
Lower	On Off	90 ___	Lower	On Off	90 ___	Lower	On Off	85 ___

NIBP

Adult			Pediatric			Neonatal		
Systolic			Systolic			Systolic		
Upper	On Off	220 ___	Upper	On Off	145 ___	Upper	On Off	100 ___
Lower	On Off	75 ___	Lower	On Off	75 ___	Lower	On Off	50 ___
Diastolic			Diastolic			Diastolic		
Upper	On Off	110 ___	Upper	On Off	100 ___	Upper	On Off	70 ___
Lower	On Off	35 ___	Lower	On Off	35 ___	Lower	On Off	30 ___
Mean			Mean			Mean		
Upper	On Off	120 ___	Upper	On Off	110 ___	Upper	On Off	80 ___
Lower	On Off	50 ___	Lower	On Off	50 ___	Lower	On Off	35 ___

ParamSet Settings

ParamSet Enable

 (Yes)

 (No)

Note If you select (No), disregard the rest of the ParamSet settings.

HR/PR ParamSet %	Upper Limit +	20% (5, 10, 15, 20, 25)
	Lower Limit -	20% (5, 10, 15, 20, 25)
Resp ParamSet %	Upper Limit +	5% (5, 10, 15, 20, 25)
	Lower Limit -	5% (5, 10, 15, 20, 25)
SpO ₂ ParamSet %	Upper Limit +	5% (5, 10)
	Lower Limit -	5% (5, 10)
NIBP ParamSet %		
Systolic	Upper Limit +	15% (5, 10, 15, 20, 25)
	Lower Limit -	15% (5, 10, 15, 20, 25)
Diastolic	Upper Limit +	15% (5, 10, 15, 20, 25)
	Lower Limit -	15% (5, 10, 15, 20, 25)
Mean	Upper Limit +	10% (5, 10, 15)
	Lower Limit -	10% (5, 10, 15)

If ParamSet is enabled, the clinician can quickly and easily change the current alarm limits for any vital sign. If you choose to enable ParamSet, you can then define the percentage by which the alarm limit for each vital sign is changed.



To adjust alarm limits quickly with ParamSet

When the ParamSet message appears, press  twice.

Example

The ParamSet value for the **Upper HR/PR** alarm limit is configured to be **15%**.

Patient Jane's Upper HR/PR alarm limit is set to 100. At the default alarm settings, Jane triggers an Upper HR/PR alarm with a heart rate of 103. Her clinician, knowing that a heart rate of 103 is acceptable for Jane, wants to quickly set a higher Upper HR/PR alarm limit for this patient.

The monitor displays the message, "Press **Select** to ParamSet the upper HR/PR limit to 118." The clinician presses  to get to the HR/PR control screen and immediately presses  again to accept the ParamSet adjustment. Jane's alarm limit for Upper HR/PR is immediately changed to 118, and the main vital-signs screen is again displayed.

(103 + 15% of 103 = approximately 118)

Advancing Frontline Care™

Note The ParamSet default values can be changed only by downloading another monitor configuration.

When monitor power is cycled, the factory default alarm limits and ParamSet default values are again in effect.

ParamSet can be used multiple times for any alarm limit. Each time you press ParamSet for a given vital sign, the alarm limit expands by the configured percentage. However, the alarm limits can **never** be expanded beyond the limit boundaries built into the monitor. (See the specifications for vital signs in Appendix A, starting with “ECG” on page 143.)

This table shows the effect of ParamSet for various vital signs, based on a patient’s normal levels for each vital sign. These values are based on the assumption that:

- the patient mode is Adult
- the monitor is initially using factory default alarm levels

For each parameter listed below, the factory value is shown in **bold**. The factory value is used until another value is uploaded to the monitor.

Parameter		Alarming Level	Alarm Limit (ParamSet = 5%)	Alarm Limit (Paramset = 10%)	Alarm Limit (ParamSet = 15%)	Alarm Limit (Paramset = 20%)	Alarm Limit (Paramset = 25%)
HR/PR	Upper	90	94	99	104	108	113
	Lower	60	57	54	51	48	45
NIBP Systolic	Upper	140	147	154	161	168	175
	Lower	100	95	90	85	80	75
NIBP Diastolic	Upper	90	94	99	104	108	113
	Lower	60	57	54	51	48	45
NIBP MAP	Upper	107	112	118	123	128	134
	Lower	73	69	66	62	58	55
SpO ₂	Upper	100	100	100	100	100	100
	Lower	90	86	81	77	72	68
Resp	Upper	20	21	22	23	24	25
	Lower	12	11	11	10	10	9

Feature Enable

System Features

Enable Wireless Communications (with Acuity)

- (Yes)**
 (No)

For wireless monitors that must communicate with Acuity, this must be set to **(Yes)**. If this is set to (No), the monitor cannot communicate with Acuity.

For standalone monitors that do not communicate with Acuity, always set this to **(No)**. If this is set to (Yes), the configuration file is not valid and cannot be uploaded to the monitor.

Note If **(Yes)** is selected, **NIBP Units Default** (see “NIBP Units Default” on page 127) must be set to **mmHg**.

NIBP Turbo Mode Enable

- (Yes)**
 (No)

When the monitor takes automatic NIBP measurements in Turbo Mode, it takes as many measurements as possible within the 5-minute Turbo Mode measurement period.

SpO₂ Spot Check Enable

- (Yes)**
 (No)

If SpO₂ Spot Check is enabled, a clinician can perform a quick SpO₂ measurement when SpO₂ monitoring is turned off. For detailed information, see *Propaq LT Vital Signs Monitor Directions for Use*.

Lockouts

If lockouts are enabled, simultaneously pressing ▲ ▼ ► (the **Left Arrow**, **Right Arrow**, and **Down Arrow** buttons) locks out one or more of the following:

- | | |
|-------------------|------------------------------------------------------------------|
| Display | Prevent unauthorized viewing of confidential patient information |
| Back Light | Extend the battery charge life |
| Buttons | Block access to the monitor buttons |

Display Lockout Enable

- (Yes)**
 (No)

If display lockout is enabled, ▲ ▼ ► locks out the monitor display until the combination is repeated or until an alarm or alert condition arises.

Back Light Lockout Enable

- (Yes)
 (No)

If back light lockout is enabled, the 3-button combination ▲ ▼ ► locks out the monitor display back light until the combination is repeated or until an alarm or alert condition arises.

Buttons Lockout Enable

- (Yes)
 (No)

If you enable buttons lockout, the 3-button combination ▲ ▼ ► locks out normal button operation until the combination is repeated or until an alarm or alert condition arises.

Time-Outs

Display Time-Out

- 2 minutes
 5 minutes
 10 minutes
 15 minutes
 30 minutes
 Always On (display always on)

Display Time Out greatly increases monitor run time on battery power. Display Time Out completely shuts off the display if the monitor detects no button press and no alarm for a number of minutes defined below. When the display is off, no monitor information is visible.

Any alarm condition, alert condition, or button press immediately restores the display. If the buttons are locked out (see “Buttons Lockout Enable” on page 136), pressing ▲ ▼ ► and then any other button immediately restores the display.

Back Light Time-Out

- Always Off
 2 minutes
 5 minutes
 10 minutes
 15 minutes
 30 minutes
 Always On (back light always on)

Back Light Time Out increases monitor run time on battery power. Back Light Time Out turns off the back light if the monitor detects no button press and no alarm for the number of minutes defined below. When the back light is off, the display continues to be visible, although slightly dimmer, in ambient light.

Any alarm condition, alert condition, or button press immediately restores the back light. If the buttons are locked out (see “Buttons Lockout Enable” on page 136), pressing ▲ ▼ ► and then any other button immediately restores the back light.

Masimo SpO₂

Perfusion Index

- (Enable)**
- (Disable)

Signal IQ

- (Enable)**
- (Disable)

Sensitivity

- (Enable)**
- (Disable)

If enabled: **Normal**, Maximum, APOD

FastSAT

- (Enable)**
- (Disable)

Default On

- (Yes)
- (No)**

Averaging Time

- (Enable)**
- (Disable)

If enabled: 2, 4, **8**, 10, 12, 14, 16 (seconds)

Authorization

The information on this page relates only to this worksheet, and is not entered into the monitor configuration. Users are encouraged to provide their own procedures for defining, categorizing, storing, and approving configuration files.

Date _____

Hospital _____

Department _____

Name _____

Title _____

Phone _____

Signature _____

10 Maintenance

Recharging the battery

The monitor battery is recharged whenever the monitor is placed into a cradle that is connected to a suitable power source. Recharging occurs whether the monitor is on or off. While in a cradle that is connected to AC power, the monitor also receives operating power from the cradle, thus preserving battery power for use when the monitor is removed.

To recharge the battery

1. Confirm that the green “power” light (the right of two on the cradle) is on.
If it is off, plug the power adapter into the cradle.
2. Insert the monitor into the cradle until it clicks into place.
3. Confirm that the green “battery charging” light on the cradle (the left of two on the cradle) is on.
 - If the green “battery charging” light is off, the monitor battery is fully charged.
 - A steady yellow light indicates a problem with the battery or the cradle (contact a qualified service technician) or that the temperature of the battery pack is out of range.

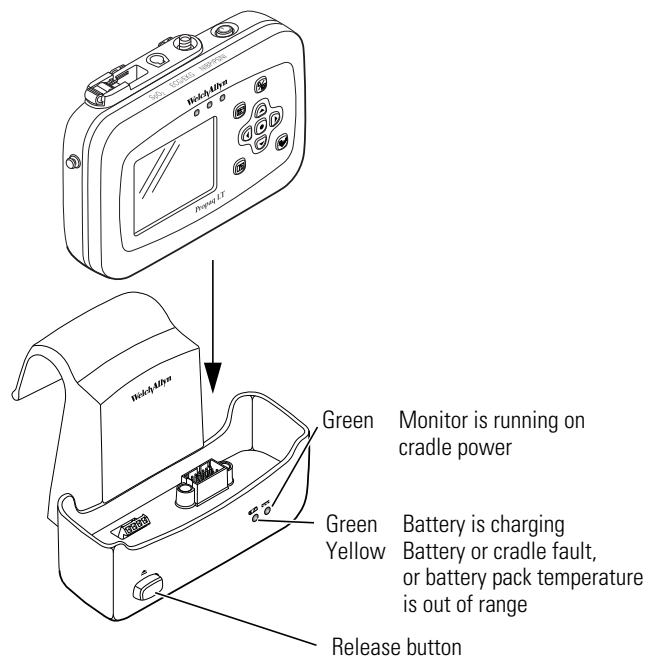

Note The yellow light might flash briefly when the monitor is being inserted in the cradle or removed from the cradle. This is normal behavior and does not indicate a problem.

4. When the battery is fully charged, the green “battery charging” light is off.
 - Keep the monitor in the cradle whenever the patient is in bed. This keeps the monitor battery at full charge, so that it is ready for use if it must be removed from the cradle.
 - You can leave the monitor in the cradle when the battery is fully charged.



WARNING Do not incinerate, submerge, crush, disassemble, or autoclave the lithium-ion battery.



Caution Do not remove or replace the battery unless you are a Welch Allyn qualified service technician.

Caution Do not use the monitor while the battery is being replaced.

Inspecting and cleaning the monitor and accessories



WARNING Do not autoclave the monitor, the cradle, the AC power adapter, or any accessories.

WARNING Do not immerse the monitor, the cradle, or the AC power adapter in liquid when cleaning. Do not immerse accessories in liquid when cleaning unless the accessory manufacturer's cleaning instructions explicitly instruct you to do so.

WARNING Fire and electrical shock hazard. Always unplug the AC power adapter from the electrical power outlet before inspecting or cleaning the cradle, the AC power adapter, or the monitor. Exposing any of these to liquids, such as cleaning solutions, while they are connected to electrical power could result in electrical shock or fire.

Before cleaning the monitor, cradle, AC power adapter, or any accessories, thoroughly inspect them.

- Look for any signs of damage and any improper mechanical function of buttons or connectors.
- Gently bend and flex cables, inspecting them for damage or extreme wear, exposed wires, or bent connectors.
- Confirm that all connectors engage securely.

Immediately report any sign of damage or malfunction to your service department.

At least once per year, thoroughly inspect the cradle and the AC adapter power cord for damage or extreme wear.

To clean the monitor, the cradle, or any accessories, follow these steps:

1. Wipe the equipment with a cloth slightly moistened (not wet) with one of the approved cleaning solutions listed in [Table 11](#) on page 141.
2. Thoroughly wipe off any excess cleaning solution. Do not let the cleaning solution run into or accumulate in connector openings, latches, or crevices. If liquid gets into connectors, dry the area with warm air, and then check the equipment to confirm that it operates properly.



Caution Use only a cleaning solution recommended by Welch Allyn for this equipment. Use of any other cleaning solutions which have a high acid content or are otherwise inappropriate can cause damage to the equipment, including cracking and deterioration of the plastic case.

Caution Always follow the mixing/diluting instructions provided by the manufacturer of the cleaning solution.



Caution Never use any of the following solutions or similar products to clean the equipment: butyl alcohol, denatured ethanol, Freon™, mild chlorine bleach solution, isopropyl alcohol (except for the SpO₂ cable), trichloroethane, trichloroethylene, acetone, Vesphene II, Enviroquat®, Staphene®, Misty®, Glutaraldehyde, Formula 409®, or Fantastik®.

Table 11. Cleaning Instructions and Cleaning Solutions

Equipment	Cleaning instructions	Approved cleaning solutions
Monitor ^a Charging/ Communication Cradle	Wipe with a nearly dry cloth moistened with cleaning solution. Thoroughly wipe off any excess cleaning solution. Do not let cleaning solution run into connector openings or crevices. ^b	Warm water, liquid soap, Coverage®, Windex®, Ovation®, hydrogen peroxide solution, Wex-cide® ^c , T.B.Q.®
ECG cable, extension cable	Consult manufacturer's instructions.	Consult manufacturer's instructions.
SpO ₂ cable, extension cable	Consult manufacturer's instructions.	Consult manufacturer's instructions.
Other accessories	Consult manufacturer's instructions.	Consult manufacturer's instructions.

- The equipment can be disinfected to comply with OSHA requirements for cleaning and decontaminating spills of blood and other body fluids. (Federal OSHA Standard on bloodborne pathogens: 29 CFR 1910.1030, 12/6/91.)
- If liquid gets into the connectors, dry the area with warm air and then verify all monitoring functions.
- Wex-cide (Wexford Labs, Inc., Kirkwood, MO) and T.B.Q. (Calgon Vestal Lab., Calgon Corp., St. Louis, MO) are disinfectants that meet OSHA requirements, are EPA approved, and will not harm the outside of the monitor, battery, or battery charger. Wipe away disinfectants with a water-dampened cloth after the manufacturer's recommended period.

Recycling monitor components

Within the EU



Do not dispose of this product as 'unsorted municipal waste'. Prepare it for reuse or separate collection as specified by Directive 2002/96/EC of the European Parliament and the Council of the European Union on Waste Electrical and Electrical Equipment (WEEE).

Note If the monitor, the cradle, or the battery is contaminated, this directive does not apply.

For more specific disposal information, see www.welchallyn.com/weee, or contact Welch Allyn Customer Service.

Outside the EU

When the monitor, the cradle, or the battery reaches end of life, recycle it locally according to national, state, and local regulations, or return it to Welch Allyn.

A

Specifications

ECG	143
Resp	146
SpO ₂	147
NIBP	148
Alarms and alerts	149
Radio	151
Flat-panel display for the Large Color Display Interface	153
Environmental	154
Physical	154
Power	156
Cradle	157

ECG

Characteristic	Specification
Regulatory standards	Meets ANSI/AAMI EC13-2002 and EN 60601-1:1990 + A1 + A2
Connector	Hypertronics 9-pin female D01 latching connector
Selectable leads	
3-lead cable	Displayable I, II or III Internally provides I, II or III
5-lead cable	Displayable I, II, III, aV _R , aV _L , aV _F , V Internally provides I/II, III and V
Cable type detection	Automatic detection and differentiation of 3- or 5-lead cable
Lead fault indicator	Displayed chest icon with flashing indicator for each electrode
ECG Size (sensitivity)	0.2, 0.5, 1, 2, 4, and 8 mV/cm
Display sweep speed	25 mm/sec
Bandwidth (monitor display)	0.5 to 80 Hz Monitor Mode 0.05 to 80 Hz Extended Mode
Bandwidth (to Acuity)	0.05 to 80 Hz Monitor or Extended Mode
Notch filters	50 and 100 Hz, 60 and 120 Hz, or OFF, selectable at Acuity or at the monitor
Sample rate	363.64 Hz (181.82 Hz to Acuity)
Input protection	Protected against electrosurgery and defibrillator when used with ECG cables specified in the accessory list or at www.welchallyn.com .
Electrosurgery interference suppression	Included on all vectors when Welch Allyn-approved cables are used.

Lead-fail sense current	70 nA DC typical for active leads 140-280 nA DC typical for reference electrode, depending on number attached.
Tall T-wave rejection	Meets AAMI (USA) EC13-2002, section 4.1.2.1.c, up through 1.2 mV, using AAMI test waveform
Common mode rejection FILTER function OFF FILTER function ON	< 1 mV p-p RTI for 10V rms, 50/60 Hz into unbalanced input < 30 μ V p-p RTI for 10V rms, 50/60 Hz into unbalanced input
Input impedance	> 2.5 M Ω single-ended @ 60 Hz
Input range (AC)	10 mV peak-to-peak (local display) 10 mV peak-to-peak (Acuity)
Input range (DC)	Up to \pm 500 mV
Accuracy of input signal reproduction - Impulse response	Requires ECG bandwidth to be set to extended mode. ANSI/AAMI:EC 13:2002, Sec 4.2.8.9.c
System noise	\leq 30 μ V peak-to-peak, RTI notch filter on
Baseline recovery (trace restore)	Automatic
QRS detector	Adult or pediatric amplitude range: 0.22 to 5.0 mV (RTI) Neonate amplitude range: 0.1 to 5.0 mV Adult width range (duration): 70 to 120 msec Pediatric or neonate width range (duration): 40 to 120 msec
HR range (in all patient modes)	25 to 350 beats/min (measurement) 25 to 300 beats/min (display)
Alarm limits	25 to 298 beats/min (lower) 27 to 300 beats/min (upper)
HR resolution	1 beat/min
HR alarm resolution	5 beats/min
HR meter response time	Responds to change in heart rate within 13 seconds depending on physiological waveform. (As measured per AAMI standard EC13-2002 clause 5.1.2.1 (f), including 4.1.2.1 parts f. and g. waveforms.) Includes 1-second readout update interval.
HR accuracy	\pm 3 beats/min or 3%, whichever is greater
HR display update interval at monitor	1 second
AAMI HR response to "ineffectively paced QRS pattern"	Indicates rate of 30 to 46 during AAMI EC13-2002 part 5.1.4 part (f), (g), and (h) tests. NOTE: AAMI Test 5.1.4 part (f), (g), and (h): Accuracy is affected when QRS and pacer spikes are nearly simultaneous as occasionally is the case during this test.
HR averaging method	HR = 60/(latest average interval in seconds) For higher HR, latest avg interval = 7/8 (previous avg interval) + 1/8 (latest interval). For lower HR, latest avg interval = 3/4 (previous avg interval) + 1/4 (latest interval). Transition rates for choice of formula include hysteresis and are 70 and 80 beats/min.
Drift tolerance (AAMI spec. EC13-2002, 4.2.6.3)	80 beats/min indicated for 80 beats/min ECG plus drift waveform
Pacer pulse display indication	Pacer indicator (dashed vertical marker) shown on screen if pacer indicator is ON; pacer signal always shown if of sufficient amplitude.
Pacer pulse detection (i.e., for which the monitor displays a dashed vertical marker in trace)	Pulses = \pm 3.2 mV to \pm 700 mV @ 0.1 ms and \pm 2 mV to \pm 700 mV @ 0.2 to 2 ms, all with or without overshoot, in electrically quiet environment. Thresholds automatically adjust to reject repetitive ambient noise. Pacer detector influences QRS picking even while pacer display indication is disabled.

Pacer pulse rejection	Does not count as heartbeats approximately 95% of pacemaker pulses within pacer pulse detection range*, with or without AAMI (EC 13-2002) tails of 4, 8, 15, 25, 50, 75, or 100 ms decay time constant, whose tail amplitudes meet either EC 13's method A or method B criteria for single pacer pulses, or A-V sequential pulses (150 ms and 250 ms separation), all per AAMI tests 4.1.4.1 and 4.1.4.2. * Rejects method B overshoots for $[\text{pulse width}] \times [\text{pulse amplitude}] < 3 \times 10^{-4} \text{ V-sec.}$
Pacer pulse detector minimum slew rate detection threshold	2.5 V/sec RTI, per EC13:2002, 4.1.4.3
ECG trace duration	3 seconds in single or double trace display 6 seconds in cascade
Response to Irregular Rhythm (AAMI specification EC13-2002, 4.1.2.1. Part e.)	
Ventricular bigeminy (VB)	78 to 82 beats/min (80 beats/min expected)
Slow alternating VB	57 to 65 beats/min (60 beats/min expected)
Rapid alternating VB	118 to 123 beats/min (120 beats/min expected)
Bidirectional systole	88 to 93 beats/min (90 beats/min expected)
1 mV ventricular tachycardia	197 to 198 beats/min (206 beats/min expected)
2 mV ventricular tachycardia	193 to 197 beats/min (195 beats/min expected)

Resp

Characteristic	Specification
Connector (shared with ECG)	Hypertronics 9-pin, female D01 latching connector
Input protection	Electrosurgery and defibrillator protected and Resp fully functional when used with any of the ECG cables specified in the accessory list or at www.welchallyn.com .
Electrosurgery interference suppression	Yes, but not quantifiable.
Selectable Leads	Ld-1 (RA-LA), or Ld-2 (RA-LL) from either 3-lead cable or 5-lead cable, when using an ECG cable specified for this monitor in the accessory list or at www.welchallyn.com .
Base impedance range (in addition to 1K resistors in ECG cable)	Approximately 200 ohms to 1200 ohms is normal monitoring range. Approximately 1200 –1500 ohms range produces equipment alert "Resp Fault. Noisy signal. Check electrodes". Above approximately 1500 ohms produces equipment alert "Resp Fault. Lead Fail". Thresholds depend on ECG cable type and length.
Impedance dynamic range	20 ohms
Baseline recovery (trace restore)	Automatic
Resp size (sensitivity) selections	0.5X, 1X, 2X, 4X, 8X, 16X
Signal bandwidth after detection (Monitor display and at Acuity)	0.05 to 4.0 Hz at 3dB point
Sample rate	22.73 Hz
Cardiovascular artifact (CVA) rejection	Presence of CVA is detected automatically. Breaths are picked in the presence of CVA unless the breath rate is within 5% of the heart rate or a submultiple of the heart rate.
Resp channel noise	≤ 50 milliohms peak-to-peak typical
Breath detection threshold	0.175 ohms or 2x CVA, whichever is greater, set automatically
Resp rate (RR) range	2 to 150 breaths/min (adult/pediatric mode) 3 to 150 breaths/min (neonate mode)
RR alarm limits	2 to 148 breaths/min (lower, adult/pediatric) 4 to 150 breaths/min (upper, adult/pediatric) 3 to 148 breaths/min (lower, neonate) 5 to 150 breaths/min (upper, neonate)
Resp rate resolution	1 breath/min
Resp rate alarm resolution	1 breath/min
Breath rate accuracy	± 2 breaths/min or 2%, whichever is greater
Motion artifact rejection	Not rejected
Obstructive apnea	Not detected
RR display update interval at monitor	1 second
Excitation signal characteristics	65.16 kHz, pseudosine wave, 65 µA RMS ± 5%
Display sweep speed	6.25 mm/sec

SpO₂

All sensors have a measurement range of 70% - 100%. SpO₂ complies with EN ISO 9919:2005.

Characteristic	Specification
Saturation (% SpO ₂)	
Range	1% to 100%, but limited by sensors and by sensor manufacturers' technology
Resolution	1%
Alarm limits	50% to 98% (lower) 52% to 100% (upper)
Probe accuracy (adult, pediatric, neonate)	Accuracy for saturation levels below 70% is unspecified.
Pulse rate alarm limits	25 to 298 beats/min (lower) 27 to 300 beats/min (upper)
Pulse rate accuracy	± 3 beats/min typical; varies with sensor model
Display update interval at the monitor	1 second
Alarm hold-off period	10 seconds; resets if the sensor reports levels within limits before 10 seconds elapses.
Circuitry	Microprocessor controlled Automatic self-test of oximeter when powered on Automatic setting of default parameters Automatic alarm messages
Electrosurgery interference suppression	Yes
Sensor compatibility	For a complete list of compatible sensors, refer to the accessory list or www.welchallyn.com .
Nellcor	For probe/sensor compliance to EN ISO 9919:2005, see the Nellcor directions for use.
Masimo	For probe/sensor compliance to EN ISO 9919:2005, see the Masimo directions for use.
Sensor lights (Nellcor)	
Red wavelength	660 nm (nominal), 31.3 mW (max)
Infrared wavelength	920 nm (nominal), 28.8 mW (max)
Sensor lights (Masimo)	≤ 15 mW at 50 mA pulsed
Red wavelength	660 nm
Red wavelength (toe clip)	663 nm
Infrared wavelength	905 nm
Infrared wavelength (toe clip)	880 nm
Risk mitigation: Software in this device is developed under the FDA guidance of Part 802.3 design controls and the international standard EN 14971 risk management. These mitigate and minimize any risk associated with potential software errors to a level as low as reasonably possible (ALARP).	

NIBP

Characteristic	Specification			
Method	Oscillometric			
Regulatory standards	Meets AAMI SP10:2002, IEC 60601-1:1990, IEC 60601-2-30:1999(E); EN 1060-1:1996, EN 1060-3:1997			
Control	Automatic (at selected intervals), turbo, and manual			
Auto intervals	1, 2, 3, 5, 10, 15, 30, and 60 minutes			
Smartcuf	Available when ECG is used			
Reported pressures	Systolic, diastolic, and mean plus real-time manometer pressure			
Pressure resolution	1 mmHg			
Systolic range	Adult	30 to 260 mmHg		
	Pediatric	30 to 160 mmHg		
	Neonate	25 to 120 mmHg		
Alarm limits	Adult	low 30 to 258 mmHg	high 32 to 260 mmHg	
	Pediatric	low 30 to 158 mmHg	high 32 to 160 mmHg	
	Neonate	low 25 to 118 mmHg	high 27 to 120 mmHg	
Diastolic range	Adult	20 to 235 mmHg		
	Pediatric	15 to 130 mmHg		
	Neonate	10 to 105 mmHg		
Alarm limits	Adult	low 20 to 233 mmHg	high 22 to 235 mmHg	
	Pediatric	low 15 to 128 mmHg	high 17 to 130 mmHg	
	Neonate	low 10 to 103 mmHg	high 12 to 105 mmHg	
Mean range	Adult	20 to 255 mmHg		
	Pediatric	15 to 140 mmHg		
	Neonate	10 to 110 mmHg		
Alarm limits	Adult	low 20 to 253 mmHg	high 22 to 255 mmHg	
	Pediatric	low 15 to 138 mmHg	high 17 to 140 mmHg	
	Neonate	low 10 to 108 mmHg	high 12 to 110 mmHg	
Pulse rate range	30 to 220 beats/min, in adult, pediatric, and neonate modes			
Alarm limits	Low	25 to 298 beats/min		
	high	27 to 300 beats/min		
Static manometer accuracy	0-300mmHg \pm 3 mmHg or 2% of reading, whichever is greater. Can be checked in the field, but no adjustments are provided (or needed).			
Manometer baselining (zeroing)	Automatic			
Atmospheric pressure compensation	Automatic			
Minimum inflation pressure	Adult	100 mmHg		
	Pediatric	80 mmHg		
	Neonate	50 mmHg		
Maximum inflation pressure	Adult	270 mmHg		
	Pediatric	170 mmHg		
	Neonate	132 mmHg		
Default inflation pressure	Adult	160 mmHg		
	Pediatric	120 mmHg		
	Neonate	90 mmHg		

Normal overpressure limit	Adult	280 mmHg
	Pediatric	200 mmHg
	Neonate	141 mmHg
Single fault overpressure limit	Adult	308 mmHg
	Pediatric	220 mmHg
	Neonate	154 mmHg
Leak rate (manufacturing spec)	After a 1-minute settling period, not more than 1 mmHg per second at 200 mmHg when connected to a volume of at least 15 cc.	
Rapid exhaust (dump) time	3 seconds typical to drop pressure in a 500 cc volume from 300 mmHg to < 10 mmHg	
Cuff inflation time	7-8 seconds typical to 270 mmHg into a 500 cc volume in adult mode at sea level	
Maximum determination time (without retries)	Adult	3 minutes
	Pediatric	2 minutes
	Neonate	1.5 minutes
Minimum time between automatic measurements	30 seconds (Auto Mode)	
	2 seconds (Turbo Mode)	
Allowable retries	Two in each patient mode	
Electrosurgery interference suppression	Included	

Alarms and alerts

General

Characteristic	Specification	
Visual alarm indicator at the monitor		
Patient alarm	Flashing red	0.3 seconds on, 0.3 seconds off
Equipment alert	Flashing yellow	1.0 seconds on, 1.0 seconds off
Any alarm limit disabled	Continuous yellow	
Visual alarm indicator at Acuity (when connected)	See <i>Acuity Directions For Use</i> .	
Alarm indicators	Red lights	
Alert indicators	Yellow lights	
Audible alarm location	Monitor Acuity (when connected)	
Audio alarm/alert frequency (at the monitor)	1024 Hz	
SpO ₂ tone frequency	HR/PR tone= [165 + 5 (% Sat)] Hz When no valid saturation reading exists, the HR/PR tone is 1024 Hz.	
Audio alarm/alert volume (d = 1 meter) (Can be configured with distinct tone volume settings for standalone and networked operation.)	High	67 dB typical (A)
	Medium	60 dB typical (A)
	Low	53 dB typical (A)
	Off	
Audio alarm indicator at the monitor		

Patient alarm high-priority limit violation	[100 ms on, 80 ms off, 100 ms on, 80 ms off, 100 ms on, 260 ms off, 100 ms on, 80 ms off, 100 ms on, 1 sec off, 100 ms on, 80 ms off, 100 ms on, 80 ms off, 100 ms on, 260 ms off, 100 ms on, 80 ms off, 100 ms on, 4 sec off]; repeat.	
Equipment alert medium priority	[160 ms on, 200 ms off, 160 ms on, 200 ms off, 160 ms on, 3.96 sec off]; repeat.	
Limits	Settable on all parameters Separate adult/pediatric/neonate mode settable limits	
Alarm control	Automatic preset or manual settings	
Alarm priority	High Medium Low	Patient alarms (Life-threatening) Equipment alerts Alarm off
Alarm on tachycardias	Most tachycardias alarm in less than 8 seconds. These include AAMI 3.1.2.1 part f. waveforms. Certain multifocal tachycardias can initially alarm as "low rate."	
Alarm hold-off period	HR/PR % SpO ₂ RR	3 seconds 10 seconds 5 seconds To keep false alarms to a minimum, the monitor briefly delays or "holds off" triggering audible and visual alarms for limit violations for these vital signs. After the hold-off period begins, if the monitor detects that the vital sign has returned to acceptable limits, the monitor cancels the alarm. The next time a limit is violated, the monitor starts a new hold-off.
Audio alarm hold-off with Acuity	When a monitor is connected to Acuity, the audio alarms at the monitor can be delayed up to 4 minutes and 15 seconds. The delay time is selected in Acuity software at the time of Acuity installation. Visual alarm indications are not delayed. Acuity has a default audio alarm hold-off of 11 seconds.	
Alarms suspend	When 'alarms suspend' is enabled, the monitor alarm tones for all parameters can be suspended on the floor for a configurable period: 90 seconds, 2 minutes, 3 minutes, 4 minutes (default), 5 minutes, 10 minutes, 15 minutes, or 60 minutes.	
Patient out-of-range; transmitter failure	When a monitor is used with Acuity, an equipment alert is generated whenever the monitor fails to communicate with Acuity after a connection has been successfully established. In addition, the 'No Acuity' icon is displayed on the monitor.	
Battery failure	An equipment alert is generated before the monitor battery becomes exhausted.	
Snapshot/event mark	When  is pressed, the monitor records a Snapshot. If the monitor is connected to Acuity, the monitor also sends a message to Acuity so Acuity can mark and print it.	

Default limits

Characteristic	Specification			
	Upper		Lower	
HR/PR	Adult	120 beats/min	Adult	50 beats/min
	Pediatric	150 beats/min	Pediatric	50 beats/min
	Neonate	200 beats/min	Neonate	100 beats/min
Resp	Adult	30 breaths/min	Adult	5 breaths/min
	Pediatric	45 breaths/min	Pediatric	10 breaths/min
	Neonate	60 breaths/min	Neonate	10 breaths/min

SpO₂	Adult	100%	Adult	90%
	Pediatric	100%	Pediatric	90%
	Neonate	95%	Neonate	85%
NIBP Systolic	Adult	220	Adult	75
	Pediatric	145	Pediatric	75
	Neonate	100	Neonate	50
NIBP Diastolic	Adult	110	Adult	35
	Pediatric	100	Pediatric	35
	Neonate	70	Neonate	30
NIBP MAP	Adult	120	Adult	50
	Pediatric	110	Pediatric	50
	Neonate	80	Neonate	35

Display

Characteristic	Specification
Type	Color transfective; LCD module
Resolution	320 x 240 pixels Quarter VGA
Active viewing area	> 3.5" (8.9 cm) diagonal
Pixel pitch	0.2235 mm X 0.2235 mm
Viewing angle	± 40° from normal, horizontal and vertical; Contrast ratio > 2
Daylight viewable	Daylight viewable with backlight off
Back light	Display back light can be turned on or off
Brightness (back light full on)	160 cd/m ² typical
Contrast ratio	85 typical (Back light on)
Display colors	256

Radio

5 GHz: Models 802LTAN and 802LTAS

Characteristic	Specification
FlexNet™ Network	5-GHz orthogonal frequency division multiplexing (OFDM) wireless local area network (WLAN) and 10/100/1000 base-T Ethernet network
Frequency	5.150 to 5.825 GHz (subject to country-specific regulations within this range)
Modulation	OFDM
Output power	40 mW maximum
IEEE standards	802.11a, 802.11e, 802.11h, 802.11i, 802.1X
Monitors per access point	20 (max.)

Military radars are allocated as primary users in the bandwidths between 5.25 - 5.35 GHz and 5.47 to 5.725 GHz.



WARNING In the event a radar signature is detected, the access point moves to a new channel, which can temporarily interrupt patient monitoring.



Caution If the device is operated near a military radar, the radar could cause damage to the device.



Caution Some countries restrict the use of 5-GHz bandwidths. The 802.11a radio in the Model 802LTA monitors uses only the channels indicated by the access point with which the radio associates. The hospital IT department must therefore configure all associated access points to operate within approved domains.

Channel restrictions in the 5-GHz band, by country, are as follows:

Restrictions for use in the 5-GHz bands^a		
Allowed frequency bands^b	Allowed channel numbers^c	Countries
5.15 to 5.25 GHz	36, 40, 44, 48	Austria
5.15 to 5.35 GHz	36, 40, 44, 48, 52, 56, 60, 64	Cyprus, Czech Republic, France, Hungary, Slovakia
5.15 to 5.35 GHz and 5.470 to 5.725 GHz	36, 40, 44, 48, 52, 56, 60, 64, 100, 104, 108, 112, 116, 120, 124, 128, 132, 136, 140	Belgium, Bulgaria, Denmark, Estonia, Finland, Germany, Greece, Iceland, Ireland, Italy ^d , Latvia, Liechtenstein, Lithuania, Luxembourg, Malta, Netherlands, Norway, Poland, Portugal, Slovenia, Spain, Sweden, Switzerland, U.K.

- This device must not be operated outdoors when using the bands 5150 to 5350 MHz (Channels 36, 40, 44, 48, 52, 56, 50, 64).
- This device must be used with Access Points that have employed and activated a radar detection feature required for European Community operation in the 5-GHz bands. This device operates under the control of the Access Point to avoid operating on a channel occupied by any radar system in the area. The presence of nearby radar operation may result in temporary interruption in communications of this device. The Access Point's radar detection feature automatically restarts operation on a channel free of radar. You may consult with the local technical support staff responsible for the wireless network to ensure that the Access Point device(s) is properly configured for European Community operation.
- To remain in conformance with European laws of spectrum usage for Wireless LAN operation, the 5-GHz channel limitations listed above apply. The user must check the current channel of operation. If operation occurs outside the allowable frequencies listed above, the user must cease operating the device at that location and consult the local technical support staff responsible for the wireless network.
- In Italy the end-user must apply for a license from the national spectrum authority to operate this device outdoors.

2.4 GHz: Models 802LTRN and 802LTRS

Characteristic	Specification
FlexNet™ Network	2.4-GHz frequency-hopping spread-spectrum (FHSS) wireless local area network (WLAN) and 10/100 base-T Ethernet network
Frequency	2.402 to 2.480 GHz (subject to country-specific variations within this range)
Modulation	GPSK
Output power	100 mW
IEEE 802.11 compliant	Yes
Monitors per access point	15 (max.)

Flat-panel display for the Large Color Display Interface

These specifications are based on a 17-inch (diagonal measure) display with a 5:4 aspect ratio or a 22-inch (diagonal measure) display with a 16:9 aspect ratio.

Size	17" or 22" diagonal
Resolution	Must be compatible to 1024 dots x 768 lines. 49.72KHz Horizontal, 62.46Hz vertical and 66.818 MHz Pixel Clock.
Video signal	Analog RGB (0.7 V p-p, 75 ohms)
Input connections	15-pin D-sub

To meet AAMI standard EC13 while using a larger or smaller display, select a display with the appropriate ratio characteristics. For example, the tables below shows ECG waveform aspect ratios and sensitivities for a representative selection of displays.

Note Welch Allyn has tested **only** the information for the 17" @ 5:4 display.

17-inch display

Display size (inches)	Aspect ratio	mm/s	mm/mV
13.3 @ 3:4 ^a	0.40	20.0 ^a	7.9 ^a
15 @ 3:4 ^a	0.40	22.5	8.9 ^a
17 @ 5:4	0.42	25.0	11
19 @ 5:4 ^a	0.42	27.8 ^a	12 ^a
21.3 @ 3:4 ^a	0.40	32.0 ^a	13 ^a
24 @ 8:5 ^a	0.33	38.3 ^a	13 ^a

a. Out of specification.

Note Welch Allyn has tested **only** the information for the 22" @ 16:9 display.

Display size (inches)	Aspect ratio	mm/s	mm/mV
18.5 @ 16:9 ^a	0.40	21.6 ^a	8.7 ^a
20 @ 16:9	0.40	23.4	9.4
21.5 @ 16:9	0.40	25.1	10.1
22 @ 16:9	0.40	25.1	10.1
23 @ 16:9	0.40	26.8	10.8
24 @ 16.9 ^a	0.40	28.0 ^a	11.3 ^a

a. Out of specification.

Environmental



Caution The monitor might not meet performance specifications if it is not used or stored within these environmental specifications.

Note The specifications apply when the battery is installed and the battery cover is in place.

Characteristic	Specification
Operating temperature	0° to 40° C
Shipping and storage temperature	-20° to 60° C for monitor and cradle. See "Battery" on page 157 for details about long-term storage of the internal monitor battery.
Operating altitude	-2,000 to 15,000 ft (-610 to 4,572 m)
Shipping and storage altitude	-2,000 to 40,000 ft (-610 to 12,192 m)
Operating relative humidity	5% to 95%, noncondensing per MIL STD 810E, Procedure 1-natural
Shipping and storage relative humidity	5% to 95%, noncondensing per MIL STD 810E, Procedure 1-natural
Water resistance	IPX1
Drop	2 meters onto oak on concrete, exceeding the 1-meter requirement of EN60601-1. (Cosmetic damage is not considered a failure.)
Shock	75g, 11 ms half-sine waveform, three shocks on each surface (three perpendicular axes) for a total of 18 shocks, six shocks per axis, three positive and three negative. 102g, 6 ms half-sine waveform, three shocks on each surface (three perpendicular axes) for a total of 18 shocks. Six shocks per axis, three positive and three negative.
Vibration, random	10Hz to 100Hz: 5.0 (m/s ²)/Hz (.05g ² Hz), 100Hz to 200Hz at -4 dB per octave; 200Hz to 500Hz 2.0 (m/s ²)/Hz (.02g ² Hz), ramp to 2000Hz 1.0 (m/s ²)/Hz (.01g ² Hz). Superimposed sine frequencies of 30 Hz at 2.5g and 60,90 and 120Hz at 1.5g. Operating one hour per axis, three hours per test.
Vibration, sweep sine	
Frequency range	10 to 150 Hz
Amplitude/acceleration	± 0.15 mm/2
Sweep rate	1 octave/minute
Number of sweep cycles	4 in each axis
Electromagnetic compatibility (EMC)	EN 60601-1-2: 2001, Emission Class A for monitor with Large Color Display Interface, Emission Class B for monitor without Large Color Display Interface

Physical

Characteristic	Specification
Protection classifications, all configurations	
Type of protection against electric shock—monitor (connected to internal battery power source or to cradle.)	Battery operation or connection to isolated cradle. Battery must be charged in the monitor while the monitor is in the cradle.

Degree of protection against electric shock, for parts applied to patients	See monitor labels. Type CF, defibrillator protected.
Method of cleaning	Not suitable for autoclaving. See "Inspecting and cleaning the monitor and accessories" on page 140.
Flammable anesthetics	Not suitable for use with flammable anesthetics.
Physical dimensions	
Monitor height	5.4 in (13.71 cm)
Monitor width	7.5 in (19.05 cm)
Monitor depth	2.1 in (5.33 cm)
Monitor weight (including battery and radio card)	approximately 32 oz (0.9 kg)

Power

Characteristic	Specifications
Operating times on a new fully-charged battery for ambient temperature $\geq 20^{\circ}\text{C}$	
Standalone Continuous monitoring with minimal display use (defined as 5 minutes display use per hour)	ECG and Resp only: ≥ 24 hrs ECG, Resp, SpO ₂ , NIBP every 15 min.: ≥ 8 hours
Acuity connected (Models 802LTAN, 802LTAS, 802LTRN and 802LTRS) In communication, with continuous monitoring and minimal display use (5 min display use/hour)	ECG and Resp only: ≥ 24 hrs ECG, Resp, SpO ₂ , NIBP every 15 min.: ≥ 8 hours

Power adapter

Characteristic	Specification
Input	100-240 volts AC, 50/60 Hz, 700 mA max
Output	15 volts DC $\pm 5\%$ no load to 2A load
Output ripple	200 mV p-p maximum (90 VAC RMS, 50 Hz, 24-watt load)
Power	24 watts minimum
Holdup time	1/2 sine-wave cycle, full load, 115 V/60 Hz, 230 VAC/50 Hz, per IEC EN 61000-4-11
Overvoltage protection	Built in
Overcurrent protection	Built in
Efficiency	80% minimum at full load, 115 VAC input
Dielectric withstanding voltage	4.8 KV for 1 sec or 4.0 KV for 60 sec (mains) input to DC output
Patient leakage current	10 μA maximum, normal condition type CF per IEC EN 60601-1 50 μA maximum, single-fault condition type CF per IEC EN 60601-1
Enclosure leakage current	100 μA maximum, per IEC EN 60601-1
Protection against harmful ingress of water	IPX1 when the LED faces up IPX0 otherwise
Humidity	95% per MILT-28800 Par 4.5.5.1
Strain-Relief Strength	30 N per UL/IEC EN 60950-1 and UL/IEC EN 60601
Weight	≤ 0.8 lb
Insulation class (transformer)	UL Rated 105 $^{\circ}$ C
Width	2.68 in (68 mm)
Height	1.54 in (39 mm)
Length	4.13 in (105 mm)
Weight	10.6 oz (300 g)
AC input connector	IEC 60320-C8, 2.5 A rated input housing
DC output connector	Hypertronics DO2-size latching 3-pin male
Output cable length	8 feet for IEC power cord

Battery

Characteristic	Specification									
Type	7.4 V, rechargeable, lithium ion. Field-replaceable by service technician.									
Capacity	> 1800 mA-hr minimum									
Charger	Contained in the cradle. Batteries are charged in place in the monitor.									
Fuse rating	5A, 125V – User cannot access the fuse. Note: Internal electronic overload circuitry is used as the primary method of protection. This circuit resets itself when an overload is removed.									
Recharge time	≤ 3 hours at 25° C (typical), with monitor either on or off.									
Storage	<table border="0"> <tr> <td>< 30 days</td> <td>-4°F to 122°F</td> <td>-20°C to 50°C</td> </tr> <tr> <td>30 days to 90 days</td> <td>-4°F to 104°F</td> <td>-20°C to 40°C</td> </tr> <tr> <td>> 90 days</td> <td>-4°F to 86°F</td> <td>-20°C to 30°C</td> </tr> </table> <p>NOTE: For best charge retention during extended storage, remove the battery from the monitor.</p>	< 30 days	-4°F to 122°F	-20°C to 50°C	30 days to 90 days	-4°F to 104°F	-20°C to 40°C	> 90 days	-4°F to 86°F	-20°C to 30°C
< 30 days	-4°F to 122°F	-20°C to 50°C								
30 days to 90 days	-4°F to 104°F	-20°C to 40°C								
> 90 days	-4°F to 86°F	-20°C to 30°C								

Cradle

Characteristic	Specification
Functional	
Capacity	One monitor with internal battery.
Mounting	Tabletop or bed rail use. Can be attached to walls, IV poles, etc. with third-party mounting brackets.
Protection Classifications	
Duty cycle	Continuous
Type of protection against electric shock	Type CF isolation exists between the monitor installed in the cradle and the cradle DC power input, regardless of type of DC power input. The line-operated power adapter accessory is a type CF medical-grade power supply. Type CF isolation exists between the monitor installed in the cradle and the cradle USB connector.
Degree of protection against harmful ingress of water	IPX1
Method of cleaning	Not suitable for autoclaving. See "Inspecting and cleaning the monitor and accessories" on page 140.
Flammable anesthetics	Not suitable for use with flammable anesthetics.
Environmental	
Operating temperature	0° to 40° C
Shipping and storage temperature	-20° to 60° C
Operating altitude	-500 to 15,000 feet (-152 to 4,572 m)
Shipping and storage altitude	-2,000 to 40,000 feet (-610 to 12,192 m)
Operating relative humidity	5% to 95%, noncondensing
Shipping, storage relative humidity	5% to 95%, noncondensing
Shock	50 g

Vibration, random	0.02g ² /Hz from 10 to 500 Hz, ramping down to 0.002g ² /Hz at 2000 Hz. Superimposed sine frequencies of 30 Hz at 2.5 g and 60, 90, and 120 Hz at 1.5 g. Operating 1 hour per axis, 3 hours per test.
Electromagnetic compatibility (EMC)	with USB option EN60601-1-2:2001 Class A without USB option EN60601-1-2:2001 Class B
Physical	
Depth	6.0 in (15.24 cm)
Width	7.6 in (19.3 cm)
Height	5.7 in (14.48 cm) including feet
Weight	24 oz (0.68 kg)
Electrical	
Rated input	12V to 28V DC, 22 W max, current is inversely proportional to input voltage.
Rated fuse (externally accessible)	3A, 250V, 2AG size, type T3A.
Rated output to cradle connector	Monitor power = 2 Adc max @ 8.2V - 8.6V, depending on the battery charge level. (See Charge Scheme, below.)
Charge scheme	Constant current \approx 900 mA. Constant current for preconditioning \approx 180 mA for pack voltage of 4.3V - 6.2V. Constant voltage = 8.4V \pm 0.06V total at the battery cells.
Charge termination triggers	Charge current \approx 90 mA. Total charge timeout \approx 4 hours. Precondition charge timeout \approx 1 hour.
Charge time (with monitor on or off)	\leq 3 hours typical for battery fully discharged but not exhausted. The cradle can precondition most exhausted batteries, which adds to the total charge time. Charging terminates when the battery is fully charged or when a fault is detected.
Charge time required on a dead battery before NIBP can be used.	NIBP can be used as soon as monitor is powered by the cradle.
Output overcurrent	Electronic overload protection. If overload occurs, monitor must be removed and reinserted to reset the charger.
Cradle-to-monitor connector	Hypertronics L-Series Module D, 17-pin male
Power input connector	Hypertronics Panel Mount D02 size latching 3-pin female
Status Indicators	
Status light yellow	Battery or cradle fault (time out, temperature out of range, a cell is overcharged, overload, no battery or nonrejuvenatable battery in monitor.)
Status light green	Monitor connected and battery charging
Status light off	Monitor not connected, or monitor connected and battery fully charged
Power light green	DC input power is being applied to the cradle.
Both lights off	Cradle not powered, cradle fuse is blown, or cradle has shut itself down.
Communications Functions	
Cradle to attached PC communications	Per USB 1.1 (not fully compliant)
USB device type	Vendor-defined class, Full-Speed Communications (12 MBPS)
USB ID	Vendor: 0x0770 Device: 0x0802
USB connector	USB type B female (device)

B

Compliance

General

This 802.11a Wireless PC Card must be installed and used in strict accordance with the manufacturer's instructions as described in the user documentation that comes with the product.

This product contains encryption. It is unlawful to export out of the U.S. without obtaining a U.S. Export License.

Federal Communications Commission (FCC)

This device complies with part 15 of the FCC Rules. Operation is subject to the following two conditions: (1) This device may not cause harmful interference, and (2) this device must accept any interference received, including interference that may cause undesired operation.

This equipment has been tested and found to comply with the limits for a Class B digital device, pursuant to Part 15 of FCC Rules. These limits are designed to provide reasonable protection against harmful interference in a residential installation. This equipment generates, uses, and can radiate radio frequency energy. If not installed and used in accordance with the instructions, it may cause harmful interference to radio communications. However, there is no guarantee that interference will not occur in a particular installation. If this equipment does cause harmful interference to radio or television reception, which can be determined by tuning the equipment off and on, the user is encouraged to try and correct the interference by one or more of the following measures:

- Reorient or relocate the receiving antenna
- Increase the distance between the equipment and the receiver
- Connect the equipment to outlet on a circuit different from that to which the receiver is connected
- Consult the dealer or an experienced radio/TV technician for help

The user may find the following booklet prepared by the Federal Communications Commission helpful:

The Interference Handbook

This booklet is available from the U.S. Government Printing Office, Washington, D.C. 20402. Stock No. 004-000-0034504.

Welch Allyn is not responsible for any radio or television interference caused by unauthorized modification of the devices included with this Welch Allyn product, or the substitution or attachment of connecting cables and equipment other than specified by Welch Allyn.

The correction of interference caused by such unauthorized modification, substitution or attachment will be the responsibility of the user.

Industry Canada (IC) emissions

This device complies with RSS 210 of Industry Canada.

Operation is subject to the following two conditions: (1) this device may not cause interference, and (2) this device must accept any interference, including interference that may cause undesired operation of this device.

L'utilisation de ce dispositif est autorisée seulement aux conditions suivantes: (1) il ne doit pas produire de brouillage et (2) l'utilisateur du dispositif doit être prêt à accepter tout brouillage radioélectrique reçu, même si ce brouillage est susceptible de compromettre le fonctionnement du dispositif.

High power radars are allocated as primary users of the 5.25 to 5.35 GHz and 5.65 to 5.85 GHz bands. These radar stations can cause interference with and/or damage this device.

This Class B digital apparatus complies with Canadian ICES-003.

Cet appareil numérique de la classe B est conforme à la norme NMB-003 du Canada.

European Union

Czech	Welch Allyn tímto prohlašuje, že tento <i>RLAN device</i> je ve shodě se základními požadavky a dalšími příslušnými ustanoveními směrnice 1999/5/ES.
Danish	Undertegnede Welch Allyn erklærer herved, at følgende udstyr RLAN device overholder de væsentlige krav og øvrige relevante krav i direktiv 1999/5/EF.
Dutch	Hierbij verklaart Welch Allyn dat het toestel RLAN device in overeenstemming is met de essentiële eisen en de andere relevante bepalingen van richtlijn 1999/5/EG. Bij deze verklaart Welch Allyn dat deze RLAN device voldoet aan de essentiële eisen en aan de overige relevante bepalingen van Richtlijn 1999/5/EC.
English	Hereby, Welch Allyn, declares that this RLAN device is in compliance with the essential requirements and other relevant provisions of Directive 1999/5/EC.
Estonian	Käesolevaga kinnitab Welch Allyn seadme RLAN device vastavust direktiivi 1999/5/EÜ põhinõuetele ja nimetatud direktiivist tulenevatele teistele asjakohastele sätetele.
Finnish	Welch Allyn vakuuttaa täten että RLAN device tyyppinen laite on direktiivin 1999/5/EY oleellisten vaatimusten ja sitä koskevien direktiivin muiden ehtojen mukainen.
French	Par la présente Welch Allyn déclare que l'appareil RLAN device est conforme aux exigences essentielles et aux autres dispositions pertinentes de la directive 1999/5/CE. Par la présente, Welch Allyn déclare que ce RLAN device est conforme aux exigences essentielles et aux autres dispositions de la directive 1999/5/CE qui lui sont applicables.
German	Hiermit erklärt Welch Allyn, dass sich dieser/diese/dieses Managed Access Point in Übereinstimmung mit den grundlegenden Anforderungen und den anderen relevanten Vorschriften der Richtlinie 1999/5/EG befindet. (BMWi) Hiermit erklärt Welch Allyn die Übereinstimmung des Gerätes RLAN device mit den grundlegenden Anforderungen und den anderen relevanten Festlegungen der Richtlinie 1999/5/EG. (Wien)
Greek	ΜΕ ΤΗΝ ΠΑΡΟΥΣΑ Welch Allyn ΔΗΛΩΝΕΙ ΟΤΙ RLAN device ΣΥΜΜΟΡΦΩΝΕΤΑΙ ΠΡΟΣ ΤΙΣ ΟΥΣΙΩΔΕΙΣ ΑΠΑΙΤΗΣΕΙΣ ΚΑΙ ΤΙΣ ΛΟΙΠΕΣ ΣΧΕΤΙΚΕΣ ΔΙΑΤΑΞΕΙΣ ΤΗΣ ΟΔΗΓΙΑΣ 1999/5/ΕΚ.
Hungarian	Alulírott, Welch Allyn nyilatkozom, hogy a RLAN device megfelel a vonatkozó alapvető követelményeknek és az 1999/5/EC irányelv egyéb előírásainak.
Italian	Con la presente Welch Allyn dichiara che questo RLAN device è conforme ai requisiti essenziali ed alle altre disposizioni pertinenti stabilite dalla direttiva 1999/5/CE.
Latvian	Ar šo Welch Allyn deklarē, ka <i>RLAN device</i> atbilst Direktīvas 1999/5/EK būtiskajām prasībām un citiem ar to saistītajiem noteikumiem.
Lithuanian	Šiuo Welch Allyn deklaruoją, kad šis RLAN device atitinka esminius reikalavimus ir kitas 1999/5/EB Direktyvos nuostatas.
Malti	Hawnhekk, Welch Allyn, jiddikjara li dan RLAN device jikkonforma mal-htigijiet essenzjali u ma provvedimenti oħrajn relevanti li hemm fid-Direttiva 1999/5/EC.

Portuguese	Welch Allyn declara que este RLAN device está conforme com os requisitos essenciais e outras disposições da Directiva 1999/5/CE.
Slovak	Welch Allyn týmto vyhlasuje, že RLAN device spĺňa základné požiadavky a všetky príslušné ustanovenia Smernice 1999/5/ES.
Slovene	Šiuo Welch Allyn deklaruojă, kad ŝis RLAN device atitinka esminius reikalavimus ir kitas 1999/5/EB Direktyvos nuostatas.
Spanish	Por medio de la presente Welch Allyn declara que el RLAN device cumple con los requisitos esenciales y cualesquiera otras disposiciones aplicables o exigibles de la Directiva 1999/5/CE.
Swedish	Härmed intygar Welch Allyn att denna RLAN device står i överensstämmelse med de väsentliga egenskapskrav och övriga relevanta bestämmelser som framgår av direktiv 1999/5/EG.

EMC

Special precautions concerning electromagnetic compatibility (EMC) must be taken for all medical electrical equipment.

- All medical electrical equipment must be installed and put into service in accordance with the EMC information provided in this document.
- Portable and mobile RF communications equipment can affect the behavior of medical electrical equipment.

Propaq LT Series monitors and accessories comply with all applicable and required standards for electromagnetic interference.

- They do not normally affect nearby equipment and devices.
- They are not normally affected by nearby equipment and devices.
- It is safe to operate them in the presence of high-frequency surgical equipment; however, it is good practice to avoid using the monitors near other equipment.

Monitor, battery-operated

The EMC specifications listed on pages 163 to 174 apply to Propaq LT monitors using any ECG cable listed in the accessory list or at www.welchallyn.com. For other EMC specifications, see “Monitor, battery-operated, with cable 008-0799-00/01” on page 175.

Guidance and manufacturer’s declaration—electromagnetic emissions

The battery-operated Propaq LT Series monitor is intended for use in the electromagnetic environment specified below. The customer or the user of the monitor should assure that it is used in such an environment.

Emissions test	Compliance	Electromagnetic environment—guidance
RF emissions CISPR 11	Group 1	The battery-operated Propaq LT Series monitor uses RF energy only for its internal function. ^a Therefore, its RF emissions are very low and are not likely to cause any interference in nearby electronic equipment.
RF emissions CISPR 11	Class B	The battery-operated Propaq LT Series monitor is suitable for use in all establishments, including domestic establishments and those directly connected to the public low-voltage power supply network that supplies buildings used for domestic purposes.
Harmonic emissions IEC 61000-3-2	No connection to mains (battery-operated)	
Voltage fluctuations/flicker emissions IEC 61000-3-3	No connection to mains (battery-operated)	

- a. The battery-operated Propaq LT Series monitor contains either a 5-GHz orthogonal frequency-division multiplexing transmitter or a 2.4-GHz frequency-hopping spread-spectrum transmitter for the purpose of wireless communication. The radio is operated according to the requirements of various agencies, including FCC 47 CFR 15.247 and R&TTE Directive (1995/5/EC). The radio is excluded from the EMC requirements of 60601-1-2:2001, but should be considered when addressing possible interference issues between this and other devices.

Guidance and manufacturer's declaration—electromagnetic immunity

The battery-operated Propaq LT Series monitor is intended for use in the electromagnetic environment specified below. The customer or the user of the monitor should assure that it is used in such an environment.

Immunity test	IEC 60601 test level	Compliance level	Electromagnetic environment—guidance
EN ISO9919	20 V/m. 1 KHz AM modulation	20 V/m	Intended for use during patient transport outside the healthcare facility
Electrostatic discharge (ESD) IEC 61000-4-2	±6 kV contact ±8 kV air	±6 kV contact ±8 kV air	Floors should be wood, concrete, or ceramic tile. If floors are covered with synthetic material, the relative humidity should be at least 30%.
Electrical fast transient/burst IEC 61000-4-4	±2 kV for power supply lines ±1 kV for input/output lines	No connection to mains (battery-operated). No other cables requiring EFT/Burst testing.	Since there is no connection to the mains, there is no requirement for mains quality.
Surge IEC 61000-4-5	±1 kV differential mode ±2 kV common mode	No connection to mains (battery-operated).	
Voltage dips, short interruptions, and voltage variations on power-supply input lines IEC 61000-4-11	<5% U_t (>95% dip in U_t) for 0.5 cycle 40% U_t (60% dip in U_t) for 5 cycles 70% U_t (30% dip in U_t) for 25 cycles <5% U_t (>95% dip in U_t) for 5 sec	No connection to mains (battery-operated).	
Power frequency (50/60 Hz) magnetic field IEC 61000-4-8	3 A/m	3 A/m	Power frequency magnetic fields should be at levels characteristic of a typical location in a typical commercial or hospital environment.

Note U_t is the AC mains voltage prior to application of the test level.

Guidance and manufacturer’s declaration—electromagnetic immunity

The battery-operated Propaq LT Series monitor is intended for use in the electromagnetic environment specified below. The customer or the user of the monitor should assure that it is used in such an environment.

Immunity test	IEC 60601 test level	Compliance level	Electromagnetic environment—guidance
Conducted RF IEC 61000-4-6	3 V _{rms} 150 kHz to 80 MHz 2Hz AM	3 V _{rms}	<p>Portable and mobile RF communications equipment should be used no closer to any part of the battery-operated Propaq LT Series monitor, including cables, than the recommended separation distance calculated from the equation applicable to the frequency of the transmitter.</p> <p>Recommended separation distance</p> $d = 1.2 \sqrt{P}$
Radiated RF IEC 61000-4-3	3 V/m 80 MHz to 2.5 GHz 2Hz AM	3 V/m	$d = 1.2 \sqrt{P} \quad 80 \text{ MHz to } 800 \text{ MHz}$ $d = 2.3 \sqrt{P} \quad 800 \text{ MHz to } 2.5 \text{ GHz}$ <p>where P is the maximum output power rating of the transmitter in watts according to the transmitter manufacturer and d is the recommended separation distance in meters.</p> <p>Field strengths from fixed RF transmitters, as determined by an electromagnetic site survey^a, should be less than the compliance level in each frequency range^b.</p> <p>Interference may occur in the vicinity of equipment marked with the following symbol:</p> 

Note 1 At 80 MHz and 800 MHz, the higher frequency range applies.

Note 2 These guidelines may not apply in all situations. Electromagnetic propagation is affected by absorption and reflection from structures, objects and people.

a Field strengths from fixed transmitters, such as base stations for radio (cellular/cordless) telephones and land mobile radios, amateur radio, AM and FM radio broadcast and TV broadcast cannot be predicted theoretically with accuracy. To assess the electromagnetic environment due to fixed RF transmitters, an electromagnetic site survey should be considered. If the measured field strength in the location in which the battery-operated Propaq LT Series monitor is used exceeds the applicable RF compliance level above, the battery-operated Propaq LT Series monitor should be observed to verify normal operation. If abnormal performance is observed, additional measures may be necessary, such as reorienting or relocating the battery-operated Propaq LT Series monitor.

b Over the frequency range 150 kHz to 80 MHz, field strengths should be less than 3 V/m.

Recommended separation distances between portable and mobile RF communications equipment and the battery-operated Propaq LT Series monitor

The battery-operated Propaq LT Series monitor is intended for use in an electromagnetic environment in which radiated RF disturbances are controlled. The customer or the user of the battery-operated Propaq LT Series monitor can help prevent electromagnetic interference by maintaining a minimum distance between portable and mobile RF communications equipment (transmitters) and the battery-operated Propaq LT Series monitor as recommended below, according to the maximum output power of the communications equipment.

Rated maximum output power of transmitter W	Separation distance according to frequency of transmitter m		
	150 kHz to 80 MHz $d = 1.2 \sqrt{P}$	80 MHz to 800 MHz $d = 1.2 \sqrt{P}$	800 MHz to 2.5 GHz $d = 2.3 \sqrt{P}$
0.01	0.12	0.12	0.23
0.1	0.38	0.38	0.73
1	1.2	1.2	2.3
10	3.8	3.8	7.3
100	12	12	23

For transmitters rated at a maximum output power not listed above, the recommended separation distance d in meters (m) can be estimated using the equation applicable to the frequency of the transmitter, where P is the maximum output power rating of the transmitter in watts (w) according to the transmitter manufacturer.

Note 1 At 80 MHz and 800 MHz, the separation distance for the higher frequency range applies.

Note 2 These guidelines may not apply in all situations. Electromagnetic propagation is affected by absorption and reflection from structures, objects and people.

Charging/communication cradle with monitor

Guidance and manufacturer's declaration—electromagnetic emissions

The Charging/Communication Cradle with Propaq LT Series monitor is intended for use in the electromagnetic environment specified below. The customer or the user of the Charging/Communication Cradle with Propaq LT Series monitor should assure that it is used in such an environment.

Note: The EMC specifications on [pages 167-170](#) apply to the following:

- Charging/Communication Cradle alone
- Propaq LT Series monitor with Charging/Communication Cradle
- Propaq LT Series monitor with Charging/Communication Cradle in communication via USB cable with personal computer

Emissions test	Compliance	Electromagnetic environment—guidance
RF emissions CISPR 11	Group 1	The Charging/Communication Cradle with Propaq LT Series monitor uses RF energy only for its internal function. Therefore, its RF emissions are very low and are not likely to cause any interference in nearby electronic equipment.
RF emissions CISPR 11	Class B	The Charging/Communication Cradle with Propaq LT Series monitor is suitable for use in all establishments, including domestic establishments and those directly connected to the public low-voltage power supply network that supplies buildings used for domestic purposes.
Harmonic emissions IEC 61000-3-2	Class A	
Voltage fluctuations/flicker emissions IEC 61000-3-3	Complies	

Guidance and manufacturer's declaration—electromagnetic immunity

The Charging/Communication Cradle with Propaq LT Series monitor is intended for use in the electromagnetic environment specified below. The customer or the user of the monitor should assure that it is used in such an environment.

Immunity test	IEC 60601 test level	Compliance level	Electromagnetic environment—guidance
Electrostatic discharge (ESD) IEC 61000-4-2	±6 kV contact ±8 kV air	±6 kV contact ±8 kV air	Floors should be wood, concrete, or ceramic tile. If floors are covered with synthetic material, the relative humidity should be at least 30%.
Electrical fast transient/burst IEC 61000-4-4	±2 kV for power supply lines ±1 kV for input/output lines	±2 kV for power supply lines ±1 kV for input/output lines	Mains power quality should be that of a typical commercial or hospital environment.
Surge IEC 61000-4-5	±1 kV differential mode ±2 kV common mode	±1 kV differential mode ±2 kV common mode	Mains power quality should be that of a typical commercial or hospital environment.
Voltage dips, short interruptions, and voltage variations on power-supply input lines IEC 61000-4-11	<5% U_t (>95% dip in U_t) for 0.5 cycle 40% U_t (60% dip in U_t) for 5 cycles 70% U_t (30% dip in U_t) for 25 cycles <5% U_t (>95% dip in U_t) for 5 sec	<5% U_t (>95% dip in U_t) for 0.5 cycle 40% U_t (60% dip in U_t) for 5 cycles 70% U_t (30% dip in U_t) for 25 cycles <5% U_t (>95% dip in U_t) for 5 sec	Mains power quality should be that of a typical commercial or hospital environment. If the user of the Charging/Communication Cradle with Propaq LT Series monitor requires continued operation during a power mains interruption, it is recommended that the Charging/Communication Cradle with Propaq LT Series monitor be powered from an uninterruptible power supply or battery.
Power frequency (50/60 Hz) magnetic field IEC 61000-4-8	3 A/m	3 A/m	Power frequency magnetic fields should be at levels characteristic of a typical location in a typical commercial or hospital environment.

Note U_t is the AC mains voltage prior to application of the test level.

Guidance and manufacturer’s declaration—electromagnetic immunity

The Charging/Communication Cradle with Propaq LT Series monitor is intended for use in the electromagnetic environment specified below. The customer or the user of the monitor should assure that it is used in such an environment.

Immunity test	IEC 60601 test level	Compliance level	Electromagnetic environment—guidance
Conducted RF IEC 61000-4-6	3 V _{rms} 150 kHz to 80 MHz 2Hz AM	3 V _{rms}	<p>Portable and mobile RF communications equipment should be used no closer to any part of the Charging/Communication Cradle with Propaq LT Series monitor, including cables, than the recommended separation distance calculated from the equation applicable to the frequency of the transmitter.</p> <p>Recommended separation distance</p> $d = 1.2 \sqrt{P}$ <p>Radiated RF IEC 61000-4-3</p> $d = 1.2 \sqrt{P} \quad 80 \text{ MHz to } 800 \text{ MHz}$ $d = 2.3 \sqrt{P} \quad 800 \text{ MHz to } 2.5 \text{ GHz}$ <p>where P is the maximum output power rating of the transmitter in watts according to the transmitter manufacturer and d is the recommended separation distance in meters.</p> <p>Field strengths from fixed RF transmitters, as determined by an electromagnetic site survey^a, should be less than the compliance level in each frequency range^b.</p> <p>Interference may occur in the vicinity of equipment marked with the following symbol:</p> 

Note 1 At 80 MHz and 800 MHz, the higher frequency range applies.

Note 2 These guidelines may not apply in all situations. Electromagnetic propagation is affected by absorption and reflection from structures, objects and people.

a Field strengths from fixed transmitters, such as base stations for radio (cellular/cordless) telephones and land mobile radios, amateur radio, AM and FM radio broadcast and TV broadcast cannot be predicted theoretically with accuracy. To assess the electromagnetic environment due to fixed RF transmitters, an electromagnetic site survey should be considered. If the measured field strength in the location in which the Charging/Communication Cradle with Propaq LT Series monitor is used exceeds the applicable RF compliance level above, the Charging/Communication Cradle with Propaq LT Series monitor should be observed to verify normal operation. If abnormal performance is observed, additional measures may be necessary, such as reorienting or relocating the Charging/Communication Cradle with Propaq LT Series monitor.

b Over the frequency range 150 kHz to 80 MHz, field strengths should be less than 3 V/m.

Recommended separation distances between portable and mobile RF communications equipment and the Charging/Communication Cradle with Propaq LT Series monitor

The Charging/Communication Cradle with Propaq LT Series monitor is intended for use in an electromagnetic environment in which radiated RF disturbances are controlled. The customer or the user of the Charging/Communication Cradle with Propaq LT Series monitor can help prevent electromagnetic interference by maintaining a minimum distance between portable and mobile RF communications equipment (transmitters) and the Charging/Communication Cradle with Propaq LT Series monitor as recommended below, according to the maximum output power of the communications equipment.

Rated maximum output power of transmitter W	Separation distance according to frequency of transmitter m		
	150 kHz to 80 MHz $d = 1.2 \sqrt{P}$	80 MHz to 800 MHz $d = 1.2 \sqrt{P}$	800 MHz to 2.5 GHz $d = 1.2 \sqrt{P}$
0.01	0.12	0.12	0.23
0.1	0.38	0.38	0.73
1	1.2	1.2	2.3
10	3.8	3.8	7.3
100	12	12	23

For transmitters rated at a maximum output power not listed above, the recommended separation distance d in meters (m) can be estimated using the equation applicable to the frequency of the transmitter, where P is the maximum output power rating of the transmitter in watts (w) according to the transmitter manufacturer.

Note 1 At 80 MHz and 800 MHz, the separation distance for the higher frequency range applies.

Note 2 These guidelines may not apply in all situations. Electromagnetic propagation is affected by absorption and reflection from structures, objects and people.

Monitor and cradle with large color display interface

Guidance and manufacturer's declaration—electromagnetic emissions

The Propaq LT Series monitor with Charging/Communication Cradle and Large Color Display Interface is intended for use in the electromagnetic environment specified below. The customer or the user of the The Propaq LT Series monitor with Charging/Communication Cradle and Large Color Display Interface should assure that it is used in such an environment.

Emissions test	Compliance	Electromagnetic environment—guidance
RF emissions CISPR 11	Group 1	The Propaq LT Series monitor with Charging/Communication Cradle and Large Color Display Interface uses RF energy only for its internal function. Therefore, its RF emissions are very low and are not likely to cause any interference in nearby electronic equipment.
RF emissions CISPR 11	Class A	The Propaq LT Series monitor with Charging/Communication Cradle and Large Color Display Interface is suitable for use in all establishments other than domestic and those directly connected to the public low-voltage power supply network that supplies buildings used for domestic purposes.
Harmonic emissions IEC 61000-3-2	Class A	
Voltage fluctuations/flicker emissions IEC 61000-3-3	Complies	

Guidance and manufacturer's declaration—electromagnetic immunity

The Propaq LT Series monitor with Charging/Communication Cradle and Large Color Display Interface is intended for use in the electromagnetic environment specified below. The customer or the user of the The Propaq LT Series monitor with Charging/Communication Cradle and Large Color Display Interface should assure that it is used in such an environment.

Immunity test	IEC 60601 test level	Compliance level	Electromagnetic environment—guidance
Electrostatic discharge (ESD) IEC 61000-4-2	±6 kV contact ±8 kV air	±6 kV contact ±8 kV air	Floors should be wood, concrete, or ceramic tile. If floors are covered with synthetic material, the relative humidity should be at least 30%.
Electrical fast transient/burst IEC 61000-4-4	±2 kV for power supply lines ±1 kV for input/output lines	±2 kV for power supply lines ±1 kV for input/output lines	Mains power quality should be that of a typical commercial or hospital environment.
Surge IEC 61000-4-5	±1 kV differential mode ±2 kV common mode	±1 kV differential mode ±2 kV common mode	Mains power quality should be that of a typical commercial or hospital environment.
Voltage dips, short interruptions, and voltage variations on power-supply input lines IEC 61000-4-11	<5% U_t (>95% dip in U_t) for 0.5 cycle 40% U_t (60% dip in U_t) for 5 cycles 70% U_t (30% dip in U_t) for 25 cycles <5% U_t (>95% dip in U_t) for 5 sec	<5% U_t (>95% dip in U_t) for 0.5 cycle 40% U_t (60% dip in U_t) for 5 cycles 70% U_t (30% dip in U_t) for 25 cycles <5% U_t (>95% dip in U_t) for 5 sec	Mains power quality should be that of a typical commercial or hospital environment. If the user of the The Propaq LT Series monitor with Charging/Communication Cradle and Large Color Display Interface requires continued operation during a power mains interruption, it is recommended that the The Propaq LT Series monitor with Charging/Communication Cradle and Large Color Display Interface be powered from an uninterruptible power supply or battery.
Power frequency (50/60 Hz) magnetic field IEC 61000-4-8	3 A/m	3 A/m	Power frequency magnetic fields should be at levels characteristic of a typical location in a typical commercial or hospital environment.

Note U_t is the AC mains voltage prior to application of the test level.

Guidance and manufacturer’s declaration—electromagnetic immunity

The Propaq LT Series monitor with Charging/Communication Cradle and Large Color Display Interface is intended for use in the electromagnetic environment specified below. The customer or the user of the Propaq LT Series monitor with Charging/Communication Cradle and Large Color Display Interface should assure that it is used in such an environment.

Immunity test	IEC 60601 test level	Compliance level	Electromagnetic environment—guidance
Conducted RF IEC 61000-4-6	$3 V_{rms}$ 150 kHz to 80 MHz 2Hz AM	$3 V_{rms}$	Portable and mobile RF communications equipment should be used no closer to any part of the Propaq LT Series monitor with Charging/Communication Cradle and Large Color Display Interface, including cables, than the recommended separation distance calculated from the equation applicable to the frequency of the transmitter. Recommended separation distance $d = 1.2 \sqrt{P}$
Radiated RF IEC 61000-4-3	$3 V/m$ 80 MHz to 2.5 GHz 2Hz AM	$3 V/m$	$d = 1.2 \sqrt{P}$ 80 MHz to 800 MHz $d = 2.3 \sqrt{P}$ 800 MHz to 2.5 GHz where P is the maximum output power rating of the transmitter in watts according to the transmitter manufacturer and d is the recommended separation distance in meters. Field strengths from fixed RF transmitters, as determined by an electromagnetic site survey ^a , should be less than the compliance level in each frequency range ^b . Interference may occur in the vicinity of equipment marked with the following symbol: 

Note 1 At 80 MHz and 800 MHz, the higher frequency range applies.

Note 2 These guidelines may not apply in all situations. Electromagnetic propagation is affected by absorption and reflection from structures, objects and people.

a Field strengths from fixed transmitters, such as base stations for radio (cellular/cordless) telephones and land mobile radios, amateur radio, AM and FM radio broadcast and TV broadcast cannot be predicted theoretically with accuracy. To assess the electromagnetic environment due to fixed RF transmitters, an electromagnetic site survey should be considered. If the measured field strength in the location in which the Propaq LT Series monitor with Charging/Communication Cradle and Large Color Display Interface is used exceeds the applicable RF compliance level above, the Propaq LT Series monitor with Charging/Communication Cradle and Large Color Display Interface should be observed to verify normal operation. If abnormal performance is observed, additional measures may be necessary, such as reorienting or relocating the Propaq LT Series monitor with Charging/Communication Cradle and Large Color Display Interface.

b Over the frequency range 150 kHz to 80 MHz, field strengths should be less than 3 V/m.

Recommended separation distances between portable and mobile RF communications equipment and the Propaq LT Series monitor with Charging/Communication Cradle and Large Color Display Interface

The Propaq LT Series monitor with Charging/Communication Cradle and Large Color Display Interface is intended for use in an electromagnetic environment in which radiated RF disturbances are controlled. The customer or the user of the Propaq LT Series monitor with Charging/Communication Cradle and Large Color Display Interface can help prevent electromagnetic interference by maintaining a minimum distance between portable and mobile RF communications equipment (transmitters) and the Propaq LT Series monitor with Charging/Communication Cradle and Large Color Display Interface as recommended below, according to the maximum output power of the communications equipment.

Rated maximum output power of transmitter W	Separation distance according to frequency of transmitter m		
	150 kHz to 80 MHz $d = 1.2 \sqrt{P}$	80 MHz to 800 MHz $d = 1.2 \sqrt{P}$	800 MHz to 2.5 GHz $d = 1.2 \sqrt{P}$
0.01	0.12	0.12	0.23
0.1	0.38	0.38	0.73
1	1.2	1.2	2.3
10	3.8	3.8	7.3
100	12	12	23

For transmitters rated at a maximum output power not listed above, the recommended separation distance d in meters (m) can be estimated using the equation applicable to the frequency of the transmitter, where P is the maximum output power rating of the transmitter in watts (w) according to the transmitter manufacturer.

NOTE 1 At 80 MHz and 800 MHz, the separation distance for the higher frequency range applies.

NOTE 2 These guidelines may not apply in all situations. Electromagnetic propagation is affected by absorption and reflection from structures, objects and people.

Monitor, battery-operated, with cable 008-0799-00/01

The EMC specifications listed on pages 175 to 186 apply only to Propaq LT monitors using ECG cables 008-0799-00 and 008-0799-01. For general EMC specifications, see “Monitor, battery-operated” on page 163.

Guidance and manufacturer’s declaration—electromagnetic emissions

The battery-operated Propaq LT Series monitor is intended for use in the electromagnetic environment specified below. The customer or the user of the monitor should assure that it is used in such an environment.

Emissions test	Compliance	Electromagnetic environment—guidance
RF emissions CISPR 11	Group 1	The battery-operated Propaq LT Series monitor uses RF energy only for its internal function. ^a Therefore, its RF emissions are very low and are not likely to cause any interference in nearby electronic equipment.
RF emissions CISPR 11	Class B	The battery-operated Propaq LT Series monitor is suitable for use in all establishments, including domestic establishments and those directly connected to the public low-voltage power supply network that supplies buildings used for domestic purposes.
Harmonic emissions IEC 61000-3-2	No connection to mains (battery-operated)	
Voltage fluctuations/flicker emissions IEC 61000-3-3	No connection to mains (battery-operated)	

- a. The battery-operated Propaq LT Series monitor contains either a 5-GHz orthogonal frequency-division multiplexing transmitter or a 2.4-GHz frequency-hopping spread-spectrum transmitter for the purpose of wireless communication. The radio is operated according to the requirements of various agencies, including FCC 47 CFR 15.247 and R&TTE Directive (1995/5/EC). The radio is excluded from the EMC requirements of 60601-1-2:2001, but should be considered when addressing possible interference issues between this and other devices.

Guidance and manufacturer's declaration—electromagnetic immunity

The battery-operated Propaq LT Series monitor is intended for use in the electromagnetic environment specified below. The customer or the user of the monitor should assure that it is used in such an environment.

Immunity test	IEC 60601 test level	Compliance level	Electromagnetic environment—guidance
Electrostatic discharge (ESD) IEC 61000-4-2	±6 kV contact ±8 kV air	±6 kV contact ±8 kV air	Floors should be wood, concrete, or ceramic tile. If floors are covered with synthetic material, the relative humidity should be at least 30%.
Electrical fast transient/burst IEC 61000-4-4	±2 kV for power supply lines ±1 kV for input/output lines	No connection to mains (battery-operated). No other cables requiring EFT/Burst testing.	Since there is no connection to the mains, there is no requirement for mains quality.
Surge IEC 61000-4-5	±1 kV differential mode ±2 kV common mode	No connection to mains (battery-operated).	
Voltage dips, short interruptions, and voltage variations on power-supply input lines IEC 61000-4-11	<5% U_t (>95% dip in U_t) for 0.5 cycle 40% U_t (60% dip in U_t) for 5 cycles 70% U_t (30% dip in U_t) for 25 cycles <5% U_t (>95% dip in U_t) for 5 sec	No connection to mains (battery-operated).	
Power frequency (50/60 Hz) magnetic field IEC 61000-4-8	3 A/m	3 A/m	Power frequency magnetic fields should be at levels characteristic of a typical location in a typical commercial or hospital environment.

Note U_t is the AC mains voltage prior to application of the test level.

Guidance and manufacturer’s declaration—electromagnetic immunity

The battery-operated Propaq LT Series monitor is intended for use in the electromagnetic environment specified below. The customer or the user of the monitor should assure that it is used in such an environment.

Immunity test	IEC 60601 test level	Compliance level	Electromagnetic environment—guidance
Conducted RF IEC 61000-4-6	3 V _{rms} 150 kHz to 80 MHz 2Hz AM	1 V _{rms}	<p>Portable and mobile RF communications equipment should be used no closer to any part of the battery-operated Propaq LT Series monitor, including cables, than the recommended separation distance calculated from the equation applicable to the frequency of the transmitter.</p> <p>Recommended separation distance</p> $d = 3.5 \sqrt{P}$
Radiated RF IEC 61000-4-3	3 V/m 80 MHz to 2.5 GHz 2Hz AM	3 V/m	$d = 1.2 \sqrt{P} \quad 80 \text{ MHz to } 800 \text{ MHz}$ $d = 2.3 \sqrt{P} \quad 800 \text{ MHz to } 2.5 \text{ GHz}$ <p>where P is the maximum output power rating of the transmitter in watts according to the transmitter manufacturer and d is the recommended separation distance in meters.</p> <p>Field strengths from fixed RF transmitters, as determined by an electromagnetic site survey^a, should be less than the compliance level in each frequency range^b.</p> <p>Interference may occur in the vicinity of equipment marked with the following symbol:</p> 

Note 1 At 80 MHz and 800 MHz, the higher frequency range applies.

Note 2 These guidelines may not apply in all situations. Electromagnetic propagation is affected by absorption and reflection from structures, objects and people.

a Field strengths from fixed transmitters, such as base stations for radio (cellular/cordless) telephones and land mobile radios, amateur radio, AM and FM radio broadcast and TV broadcast cannot be predicted theoretically with accuracy. To assess the electromagnetic environment due to fixed RF transmitters, an electromagnetic site survey should be considered. If the measured field strength in the location in which the battery-operated Propaq LT Series monitor is used exceeds the applicable RF compliance level above, the battery-operated Propaq LT Series monitor should be observed to verify normal operation. If abnormal performance is observed, additional measures may be necessary, such as reorienting or relocating the battery-operated Propaq LT Series monitor.

b Over the frequency range 150 kHz to 80 MHz, field strengths should be less than 3 V/m.

Recommended separation distances between portable and mobile RF communications equipment and the battery-operated Propaq LT Series monitor

The battery-operated Propaq LT Series monitor is intended for use in an electromagnetic environment in which radiated RF disturbances are controlled. The customer or the user of the battery-operated Propaq LT Series monitor can help prevent electromagnetic interference by maintaining a minimum distance between portable and mobile RF communications equipment (transmitters) and the battery-operated Propaq LT Series monitor as recommended below, according to the maximum output power of the communications equipment.

Rated maximum output power of transmitter W	Separation distance according to frequency of transmitter m		
	150 kHz to 80 MHz $d = 3.5 \sqrt{P}$	80 MHz to 800 MHz $d = 1.2 \sqrt{P}$	800 MHz to 2.5 GHz $d = 2.3 \sqrt{P}$
0.01	0.35	0.12	0.23
0.1	1.1	0.38	0.73
1	3.5	1.2	2.3
10	11	3.8	7.3
100	35	12	23

For transmitters rated at a maximum output power not listed above, the recommended separation distance d in meters (m) can be estimated using the equation applicable to the frequency of the transmitter, where P is the maximum output power rating of the transmitter in watts (w) according to the transmitter manufacturer.

NOTE 1 At 80 MHz and 800 MHz, the separation distance for the higher frequency range applies.

NOTE 2 These guidelines may not apply in all situations. Electromagnetic propagation is affected by absorption and reflection from structures, objects and people.

Charging/communication cradle with monitor, with cable 008-0799-00/01

Guidance and manufacturer's declaration—electromagnetic emissions

The Charging/Communication Cradle with Propaq LT Series monitor is intended for use in the electromagnetic environment specified below. The customer or the user of the Charging/Communication Cradle with Propaq LT Series monitor should assure that it is used in such an environment.

Note: The EMC specifications on [pages 167-170](#) apply to the following:

- Charging/Communication Cradle alone
- Propaq LT Series monitor with Charging/Communication Cradle
- Propaq LT Series monitor with Charging/Communication Cradle in communication via USB cable with personal computer

Emissions test	Compliance	Electromagnetic environment—guidance
RF emissions CISPR 11	Group 1	The Charging/Communication Cradle with Propaq LT Series monitor uses RF energy only for its internal function. Therefore, its RF emissions are very low and are not likely to cause any interference in nearby electronic equipment.
RF emissions CISPR 11	Class B	The Charging/Communication Cradle with Propaq LT Series monitor is suitable for use in all establishments, including domestic establishments and those directly connected to the public low-voltage power supply network that supplies buildings used for domestic purposes.
Harmonic emissions IEC 61000-3-2	Class A	
Voltage fluctuations/flicker emissions IEC 61000-3-3	Complies	

Guidance and manufacturer's declaration—electromagnetic immunity

The Charging/Communication Cradle with Propaq LT Series monitor is intended for use in the electromagnetic environment specified below. The customer or the user of the monitor should assure that it is used in such an environment.

Immunity test	IEC 60601 test level	Compliance level	Electromagnetic environment—guidance
Electrostatic discharge (ESD) IEC 61000-4-2	±6 kV contact ±8 kV air	±6 kV contact ±8 kV air	Floors should be wood, concrete, or ceramic tile. If floors are covered with synthetic material, the relative humidity should be at least 30%.
Electrical fast transient/burst IEC 61000-4-4	±2 kV for power supply lines ±1 kV for input/output lines	±2 kV for power supply lines ±1 kV for input/output lines	Mains power quality should be that of a typical commercial or hospital environment.
Surge IEC 61000-4-5	±1 kV differential mode ±2 kV common mode	±1 kV differential mode ±2 kV common mode	Mains power quality should be that of a typical commercial or hospital environment.
Voltage dips, short interruptions, and voltage variations on power-supply input lines IEC 61000-4-11	<5% U_t (>95% dip in U_t) for 0.5 cycle 40% U_t (60% dip in U_t) for 5 cycles 70% U_t (30% dip in U_t) for 25 cycles <5% U_t (>95% dip in U_t) for 5 sec	<5% U_t (>95% dip in U_t) for 0.5 cycle 40% U_t (60% dip in U_t) for 5 cycles 70% U_t (30% dip in U_t) for 25 cycles <5% U_t (>95% dip in U_t) for 5 sec	Mains power quality should be that of a typical commercial or hospital environment. If the user of the Charging/Communication Cradle with Propaq LT Series monitor requires continued operation during a power mains interruption, it is recommended that the Charging/Communication Cradle with Propaq LT Series monitor be powered from an uninterruptible power supply or battery.
Power frequency (50/60 Hz) magnetic field IEC 61000-4-8	3 A/m	3 A/m	Power frequency magnetic fields should be at levels characteristic of a typical location in a typical commercial or hospital environment.

Note U_t is the AC mains voltage prior to application of the test level.

Guidance and manufacturer’s declaration—electromagnetic immunity

The Charging/Communication Cradle with Propaq LT Series monitor is intended for use in the electromagnetic environment specified below. The customer or the user of the monitor should assure that it is used in such an environment.

Immunity test	IEC 60601 test level	Compliance level	Electromagnetic environment—guidance
Conducted RF IEC 61000-4-6	$3 V_{rms}$ 150 kHz to 80 MHz 2Hz AM	$1 V_{rms}$	Portable and mobile RF communications equipment should be used no closer to any part of the Charging/Communication Cradle with Propaq LT Series monitor, including cables, than the recommended separation distance calculated from the equation applicable to the frequency of the transmitter. Recommended separation distance $d = 3.5 \sqrt{P}$ $d = 1.2 \sqrt{P}$ 80 MHz to 800 MHz $d = 2.3 \sqrt{P}$ 800 MHz to 2.5 GHz where P is the maximum output power rating of the transmitter in watts according to the transmitter manufacturer and d is the recommended separation distance in meters. Field strengths from fixed RF transmitters, as determined by an electromagnetic site survey ^a , should be less than the compliance level in each frequency range ^b . Interference may occur in the vicinity of equipment marked with the following symbol: 
Radiated RF IEC 61000-4-3	$3 V/m$ 80 MHz to 2.5 GHz 2Hz AM	$3 V/m$	(This cell is merged with the one above and contains no additional text.)

Note 1 At 80 MHz and 800 MHz, the higher frequency range applies.

Note 2 These guidelines may not apply in all situations. Electromagnetic propagation is affected by absorption and reflection from structures, objects and people.

a Field strengths from fixed transmitters, such as base stations for radio (cellular/cordless) telephones and land mobile radios, amateur radio, AM and FM radio broadcast and TV broadcast cannot be predicted theoretically with accuracy. To assess the electromagnetic environment due to fixed RF transmitters, an electromagnetic site survey should be considered. If the measured field strength in the location in which the Charging/Communication Cradle with Propaq LT Series monitor is used exceeds the applicable RF compliance level above, the Charging/Communication Cradle with Propaq LT Series monitor should be observed to verify normal operation. If abnormal performance is observed, additional measures may be necessary, such as reorienting or relocating the Charging/Communication Cradle with Propaq LT Series monitor.

b Over the frequency range 150 kHz to 80 MHz, field strengths should be less than 3 V/m.

Recommended separation distances between portable and mobile RF communications equipment and the Charging/Communication Cradle with Propaq LT Series monitor

The Charging/Communication Cradle with Propaq LT Series monitor is intended for use in an electromagnetic environment in which radiated RF disturbances are controlled. The customer or the user of the Charging/Communication Cradle with Propaq LT Series monitor can help prevent electromagnetic interference by maintaining a minimum distance between portable and mobile RF communications equipment (transmitters) and the Charging/Communication Cradle with Propaq LT Series monitor as recommended below, according to the maximum output power of the communications equipment.

Rated maximum output power of transmitter W	Separation distance according to frequency of transmitter m		
	150 kHz to 80 MHz $d = 3.5 \sqrt{P}$	80 MHz to 800 MHz $d = 1.2 \sqrt{P}$	800 MHz to 2.5 GHz $d = 1.2 \sqrt{P}$
0.01	0.35	0.12	0.23
0.1	1.1	0.38	0.73
1	3.5	1.2	2.3
10	11	3.8	7.3
100	35	12	23

For transmitters rated at a maximum output power not listed above, the recommended separation distance d in meters (m) can be estimated using the equation applicable to the frequency of the transmitter, where P is the maximum output power rating of the transmitter in watts (w) according to the transmitter manufacturer.

NOTE 1 At 80 MHz and 800 MHz, the separation distance for the higher frequency range applies.

NOTE 2 These guidelines may not apply in all situations. Electromagnetic propagation is affected by absorption and reflection from structures, objects and people.

Monitor and cradle with large color display interface, with cable 008-0799-00/01

Guidance and manufacturer's declaration—electromagnetic emissions

The Propaq LT Series monitor with Charging/Communication Cradle and Large Color Display Interface is intended for use in the electromagnetic environment specified below. The customer or the user of the The Propaq LT Series monitor with Charging/Communication Cradle and Large Color Display Interface should assure that it is used in such an environment.

Emissions test	Compliance	Electromagnetic environment—guidance
RF emissions CISPR 11	Group 1	The Propaq LT Series monitor with Charging/Communication Cradle and Large Color Display Interface uses RF energy only for its internal function. Therefore, its RF emissions are very low and are not likely to cause any interference in nearby electronic equipment.
RF emissions CISPR 11	Class A	The Propaq LT Series monitor with Charging/Communication Cradle and Large Color Display Interface is suitable for use in all establishments other than domestic and those directly connected to the public low-voltage power supply network that supplies buildings used for domestic purposes.
Harmonic emissions IEC 61000-3-2	Class A	
Voltage fluctuations/flicker emissions IEC 61000-3-3	Complies	

Guidance and manufacturer's declaration—electromagnetic immunity

The Propaq LT Series monitor with Charging/Communication Cradle and Large Color Display Interface is intended for use in the electromagnetic environment specified below. The customer or the user of the The Propaq LT Series monitor with Charging/Communication Cradle and Large Color Display Interface should assure that it is used in such an environment.

Immunity test	IEC 60601 test level	Compliance level	Electromagnetic environment—guidance
Electrostatic discharge (ESD) IEC 61000-4-2	±6 kV contact ±8 kV air	±6 kV contact ±8 kV air	Floors should be wood, concrete, or ceramic tile. If floors are covered with synthetic material, the relative humidity should be at least 30%.
Electrical fast transient/burst IEC 61000-4-4	±2 kV for power supply lines ±1 kV for input/output lines	±2 kV for power supply lines ±1 kV for input/output lines	Mains power quality should be that of a typical commercial or hospital environment.
Surge IEC 61000-4-5	±1 kV differential mode ±2 kV common mode	±1 kV differential mode ±2 kV common mode	Mains power quality should be that of a typical commercial or hospital environment.
Voltage dips, short interruptions, and voltage variations on power-supply input lines IEC 61000-4-11	<5% U_t (>95% dip in U_t) for 0.5 cycle 40% U_t (60% dip in U_t) for 5 cycles 70% U_t (30% dip in U_t) for 25 cycles <5% U_t (>95% dip in U_t) for 5 sec	<5% U_t (>95% dip in U_t) for 0.5 cycle 40% U_t (60% dip in U_t) for 5 cycles 70% U_t (30% dip in U_t) for 25 cycles <5% U_t (>95% dip in U_t) for 5 sec	Mains power quality should be that of a typical commercial or hospital environment. If the user of the The Propaq LT Series monitor with Charging/Communication Cradle and Large Color Display Interface requires continued operation during a power mains interruption, it is recommended that the The Propaq LT Series monitor with Charging/Communication Cradle and Large Color Display Interface be powered from an uninterruptible power supply or battery.
Power frequency (50/60 Hz) magnetic field IEC 61000-4-8	3 A/m	3 A/m	Power frequency magnetic fields should be at levels characteristic of a typical location in a typical commercial or hospital environment.

Note U_t is the AC mains voltage prior to application of the test level.

Guidance and manufacturer’s declaration—electromagnetic immunity

The Propaq LT Series monitor with Charging/Communication Cradle and Large Color Display Interface is intended for use in the electromagnetic environment specified below. The customer or the user of the Propaq LT Series monitor with Charging/Communication Cradle and Large Color Display Interface should assure that it is used in such an environment.

Immunity test	IEC 60601 test level	Compliance level	Electromagnetic environment—guidance
Conducted RF IEC 61000-4-6	$3 V_{rms}$ 150 kHz to 80 MHz 2Hz AM	$1 V_{rms}$	Portable and mobile RF communications equipment should be used no closer to any part of the Propaq LT Series monitor with Charging/Communication Cradle and Large Color Display Interface, including cables, than the recommended separation distance calculated from the equation applicable to the frequency of the transmitter. Recommended separation distance $d = 3.5 \sqrt{P}$
Radiated RF IEC 61000-4-3	$3 V/m$ 80 MHz to 2.5 GHz 2Hz AM	$3 V/m$	$d = 1.2 \sqrt{P}$ 80 MHz to 800 MHz $d = 2.3 \sqrt{P}$ 800 MHz to 2.5 GHz where P is the maximum output power rating of the transmitter in watts according to the transmitter manufacturer and d is the recommended separation distance in meters. Field strengths from fixed RF transmitters, as determined by an electromagnetic site survey ^a , should be less than the compliance level in each frequency range ^b . Interference may occur in the vicinity of equipment marked with the following symbol: 

Note 1 At 80 MHz and 800 MHz, the higher frequency range applies.

Note 2 These guidelines may not apply in all situations. Electromagnetic propagation is affected by absorption and reflection from structures, objects and people.

a Field strengths from fixed transmitters, such as base stations for radio (cellular/cordless) telephones and land mobile radios, amateur radio, AM and FM radio broadcast and TV broadcast cannot be predicted theoretically with accuracy. To assess the electromagnetic environment due to fixed RF transmitters, an electromagnetic site survey should be considered. If the measured field strength in the location in which the Propaq LT Series monitor with Charging/Communication Cradle and Large Color Display Interface is used exceeds the applicable RF compliance level above, the Propaq LT Series monitor with Charging/Communication Cradle and Large Color Display Interface should be observed to verify normal operation. If abnormal performance is observed, additional measures may be necessary, such as reorienting or relocating the Propaq LT Series monitor with Charging/Communication Cradle and Large Color Display Interface.

b Over the frequency range 150 kHz to 80 MHz, field strengths should be less than 3 V/m.

Recommended separation distances between portable and mobile RF communications equipment and the Propaq LT Series monitor with Charging/Communication Cradle and Large Color Display Interface

The Propaq LT Series monitor with Charging/Communication Cradle and Large Color Display Interface is intended for use in an electromagnetic environment in which radiated RF disturbances are controlled. The customer or the user of the Propaq LT Series monitor with Charging/Communication Cradle and Large Color Display Interface can help prevent electromagnetic interference by maintaining a minimum distance between portable and mobile RF communications equipment (transmitters) and the Propaq LT Series monitor with Charging/Communication Cradle and Large Color Display Interface as recommended below, according to the maximum output power of the communications equipment.

Rated maximum output power of transmitter W	Separation distance according to frequency of transmitter m		
	150 kHz to 80 MHz $d = 3.5 \sqrt{P}$	80 MHz to 800 MHz $d = 1.2 \sqrt{P}$	800 MHz to 2.5 GHz $d = 1.2 \sqrt{P}$
0.01	0.35	0.12	0.23
0.1	1.1	0.38	0.73
1	3.5	1.2	2.3
10	11	3.8	7.3
100	35	12	23

For transmitters rated at a maximum output power not listed above, the recommended separation distance d in meters (m) can be estimated using the equation applicable to the frequency of the transmitter, where P is the maximum output power rating of the transmitter in watts (w) according to the transmitter manufacturer.

NOTE 1 At 80 MHz and 800 MHz, the separation distance for the higher frequency range applies.

NOTE 2 These guidelines may not apply in all situations. Electromagnetic propagation is affected by absorption and reflection from structures, objects and people.

Limited warranty

This product is sold by Welch Allyn under the warranties set forth in the following paragraphs. These warranties are extended only to the end user with respect to the original purchase of this product directly from Welch Allyn or from Welch Allyn's authorized distributors.

For two years (one year for remanufactured monitors) from the date of the original delivery to the buyer, the Propaq LT monitor, the Large Color Display Interface, and the Propaq LT monitor charging/communications cradle are warranted to be free from functional defects in materials and workmanship and to conform in all material respects to the description of the product contained in the directions for use and other labeling of the product.

This warranty is valid only under the following conditions:

- The product is properly operated under conditions of normal use in accordance with applicable safety and regulatory requirements;
- The product is configured, modified, adjusted and repaired only by Welch Allyn or by persons expressly authorized by Welch Allyn, in accordance with Welch Allyn's service procedures; and
- The product has not been damaged by misuse, negligence, or accident.

For a period of 90 days, unless otherwise specified, this same warranty is made for any accessories provided by Welch Allyn.

Under the above warranties, Welch Allyn's sole and exclusive obligation and buyer's sole and exclusive remedy is limited to the repair or replacement, at the discretion of Welch Allyn, free of charge, of products found to be defective during the warranty period. Warranty claims must be made, not more than seven days after expiration of the warranty period, by calling the customer service number shown below to obtain a returned material authorization number (RMA), and returning the product with the RMA documentation, transportation charges prepaid, to the address specified by Welch Allyn customer service.

Welch Allyn, Inc.
4341 State Street Road
Skaneateles Falls, NY 13153 USA
Telephone: (800) 535 6663
Fax: (315) 685 4091

Welch Allyn shall not be otherwise liable for any damages, including but not limited to incidental, consequential, or special damages.

No express or implied warranties extend beyond the warranties defined in this document. Welch Allyn makes no warranty of merchantability or fitness for a particular purpose.

Index

A

accessories, 11
 action, 31
 Acuity
 communication, 44, 73
 disconnecting, 79
 indicators on the monitor display, 17
 marking snapshot events at, 150
 monitor data stored at, 91
 overriding monitor settings, 103
 patients, arrhythmia-prone (warning), 5
 reconnecting a patient, 79
 responding to alarms at, 86
 silencing alarms at, 82
 values imposed on monitor settings, 104
 adult
 term defined, 49
 alarm
 defined, 81
 responding, 86
 alarm limits
 changing quickly with ParamSet, 85
 customizing, 84
 disabled, 149
 range, 144, 146, 147, 148
 alert
 defined, 81
 messages, 86
 responding to, 85
 anemia and SpO₂, 62
 anesthetics (warning), 4
 arterial occlusion and SpO₂, 62
 averaging time, 65

B

back light
 lock-out, 21
 time out, 20
 battery
 alert message, responding to, 88
 charging cradle, 10, 14
 conserving charge, 20

failure, 150
 fault indicator, 158
 recharging, 139
 recycling, 141
 status indicators, 2, 9, 86
 blood pressure
 see NIBP
 button
 monitor release, 16
 snapshot, 91
 using, 31
 Button Stuck, 86, 87, 89

C

cardiac arrest and SpO₂, 62
 configuration
 adjusted for individual patients, 104
 default settings, 103
 download using the cradle, 15
 imposed by Acuity, 103
 must include a waveform display, 20
 temporary, 103
 configuration author, 138
 connectors, 9
 control
 lock-out, 21
 cradle, 14
 cuff
 equipment alerts, 87
 placement, 61, 66
 target inflation pressure, 65
 customizing the monitor, 103

D

Defective SpO₂ Sensor, 86, 87, 89
 defibrillation (warning), 4
 Demo mode, 40
 display
 alert messages, 86
 lock-out, 21
 time out, 20

dual waveform display, 19

E

ECG

- changing waveform scale, 56
- lead placement, 55
- electrosurgery (warning), 4
- equipment alert
 - messages, 86
- error detection, 44

F

- FastSAT, 64
- FlexNet network, 1

H

- hazards
 - general warnings, 4
- heart rate (HR)
 - vs. pulse rate (PR), 18
- high-frequency ventilation and Resp, 53
- highlight, 31
- HIPAA considerations, 12
- hypotension and SpO₂, 62
- hypothermia and SpO₂, 62

I

- icons, 1
- indicator
 - Lead fault, 143
 - pacemaker, 57
- indicators
 - see* status indicators
- intended use, 1
- interface box, 21
 - changing waveform view, 24
 - installing, 25

L

- language, selecting, 14
- large color display interface, 21
- large numerics display, 19
- learning mode
 - see* Demo mode
- lock-out, 21

M

- maintenance
 - operator, 139
- messages for alerts, 86
- monitor
 - transporting with the patient, 45
- monitoring
 - blood pressure, 65
 - new patient, 47
 - NIBP, 65
 - paced patients, 57
 - SpO₂, 60
- motion artifact, 68
- motion interference and SpO₂, 62

N

- navigation, 31
- neonatal
 - term defined, 49
- network
 - see* Acuity
- NIBP
 - cuff and hose selection, 66
 - cuff placement, 66
 - monitoring, 65
 - warnings, 65
 - while monitoring SpO₂, 61
- noninvasive blood pressure
 - see* NIBP
- No SpO₂ Sensor Detected, 86, 87, 89

O

- operator maintenance, 139

P

- pacemaker
 - and ECG monitoring, 57
 - rate meters (warning), 4
- patient mode, 17
 - changing, 37, 50
 - warning, 5, 52
- pediatric
 - term defined, 49
- Perfusion Index, 64
- PI, 64
- power
 - AC, supplied by cradle, 14
 - interruption (warning), 5
 - on/off button, 8
 - source, filtering to reduce interference, 58
- power-up sequence, 13

- pulse
 - amplitude, 18
 - and NIBP measurement accuracy, 68
- pulse rate
 - effect on SpO₂ readings, 60
- pulse rate (PR)
 - vs. heart rate (HR), 18
- pulse rejection, pacemaker (warning), 6
- pulse tone
 - adjusting volume of, 64

R

- reconnecting a patient, 79
- release button, 16
- Resp
 - high-frequency ventilation, 53
- review patient data
 - at a PC, 95
 - at the Acuity Central Station, 95
 - creating a PDF, 101
- routine maintenance, 139

S

- safety
 - and wireless monitoring, 73
 - general warnings and cautions, 4
- sensitivity, 64
- settings
 - controlled by Acuity, 104
 - overridden by Acuity, 103
- shock and SpO₂, 62
- Signal IQ, 64
- single waveform display, 19
- SIQ, 64
- Smartcuf
 - improved NIBP accuracy, 68
- SpO₂
 - and anemia, 62
 - and arterial occlusion, 62
 - and cardiac arrest or shock, 62
 - and hypotension, 62
 - and hypothermia, 62
 - and light interference, 61
 - and motion interference, 62
 - and vasoconstriction, 62
 - monitoring, 60
 - while monitoring NIBP, 61
- spot check, 62
- status indicators, 8
 - battery, 86
 - cradle, 16, 158
 - network connection, 74
- strap

- patient carry, 46
- transport stretcher, 46
- wearable, 45
- symbols, 1

T

- tabular trends display, 19
- tabular trends with single waveform display, 19
- teaching mode
 - see* Demo mode
- time out, 20
- transporting
 - monitor and patient, 45

U

- Unrecognized SpO₂ Sensor, 86, 87, 89

V

- vasoconstriction and SpO₂, 62
- ventilation, high-frequency, and Resp, 53

W

- warnings
 - ECG monitoring, 52
 - general, 4
 - monitoring paced patients, 57
 - NIBP monitoring, 65
 - SpO₂ monitoring, 60
 - wireless monitoring, 73
- waveform display
 - and monitor configuration, 20
- wireless operation
 - warnings about limitations of, 4

